



TECNIEQUIP ANIMAL S.L.



INSEMINACION ARTIFICIAL 10/5-T

JAULA INSEMINACION ARTIFICIAL 10/5-T

Jaula para machos de inseminación avalada por los mejores especialistas.
Con reposapatras que evita el mal de patas.
Apertura frontal- superior para mejor posición de trabajo.
Protectores de orina de quita y pon.
Departamentos individuales extraíbles.

La empresa no se hace responsable en caso de no utilizar con los equipos, materiales originales Tecniequip. El precio del modulo es sin accesorios (en la fotografía esta con accesorios).



Ref. 3.799
Reposapatras
plastico y chapa



Ref. 3.4902
Tolva M2



Ref. 40.7626
Protector orines



Ref. 3.5128
Deposito reg. 8L.



Ref. 3.404070
Caña mini 5



Ref. 3.404071
Caña mini 5+5

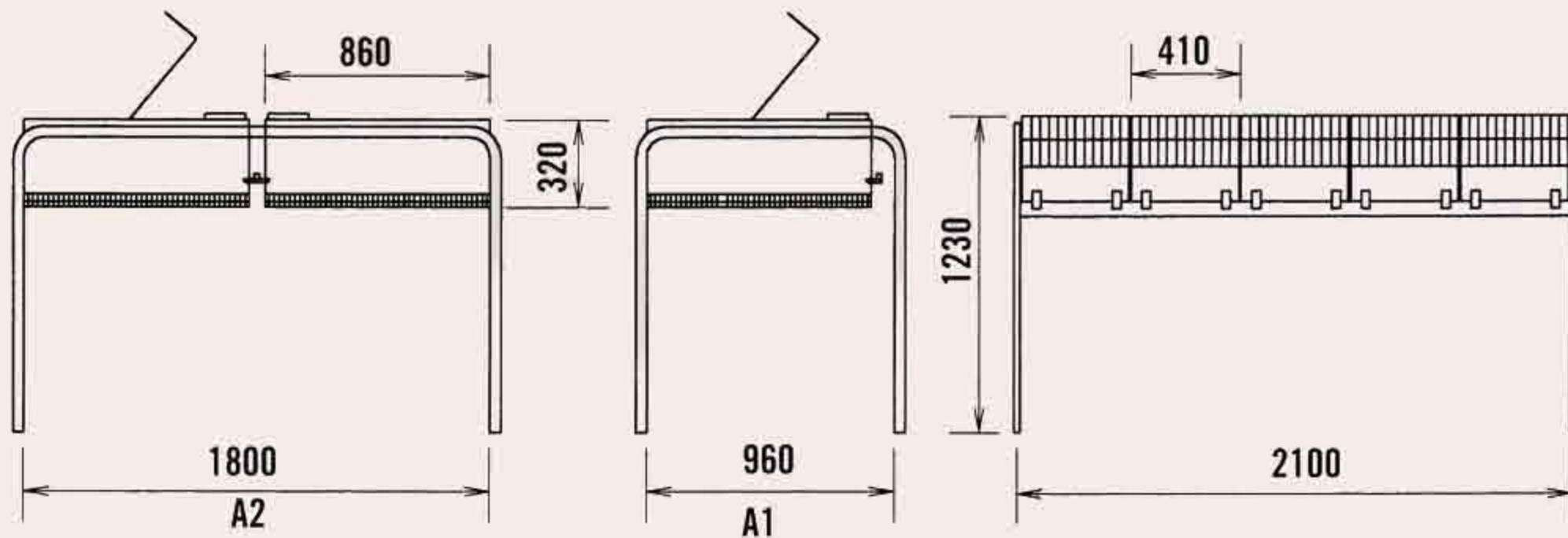



TECNIEQUIP ANIMAL S.L.



SISTEMA DE LIMPIEZA POTEN

POTEN CON TELECONTROL.

Poten es la solución eficaz para la extracción de deyecciones de todas las fosas de una granja cunícola por su flexibilidad y movilidad.

Transportable de fosa en fosa.

Grupo motriz de 2,5 cv.

Telemando hasta 750m de distancia y mando por cable a 50m.

POTEN WITH REMOTE CONTROL.

Poten is the effective solution for the extraction of excrements of all the pits of a rabbit's farm for your flexibility and mobility.

Transportable of pit in pit.

Motive group of 2,5 cv.

Remote control up to 750m of distance and control for cable to 50m

POTEN AVEC TELECONTROL.

Poten est la solution efficace pour l'extraction des excréments de toutes les fosses d'une ferme de lapins par sa flexibilité et mobilité.

Transportable d'une fosse dans une fosse.

Un groupe moteur de 2,5 cv.

Commande à distance jusqu'à 750m d'une distance et je commande par câble à 50m.

PLANO FUNCIONAMIENTO POTEN

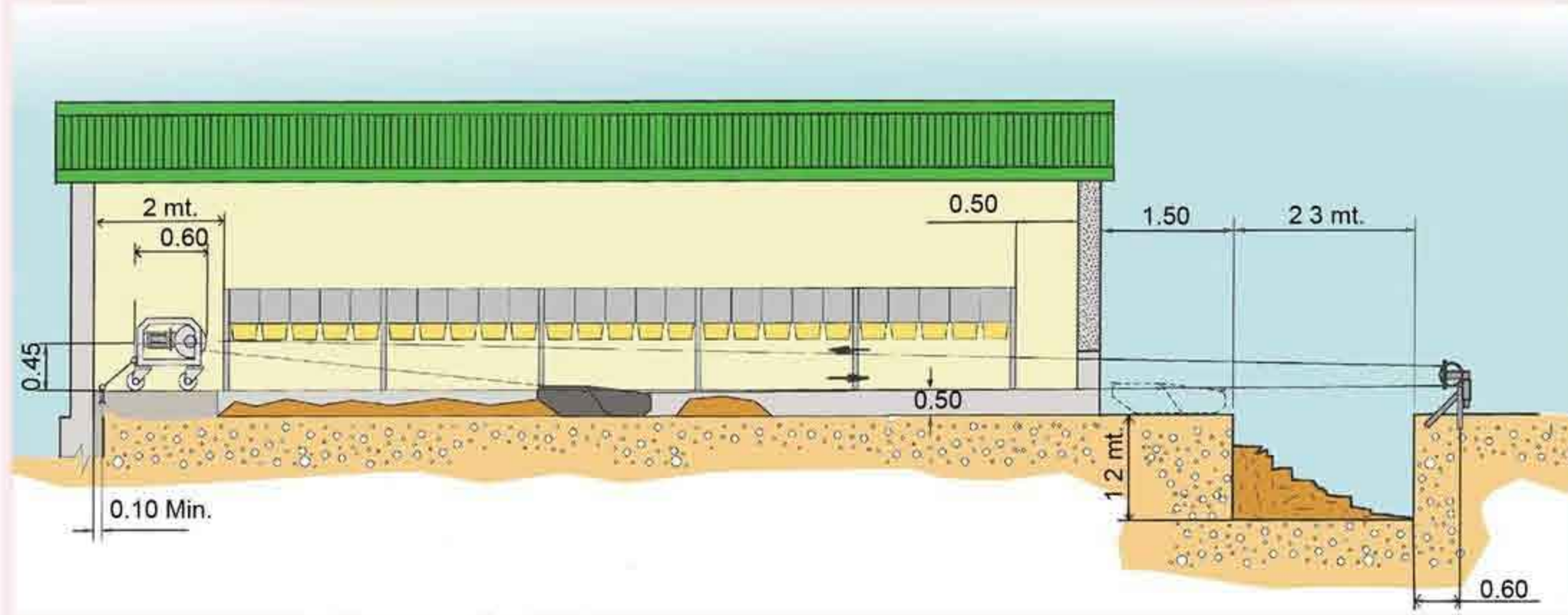

MEDIDAS

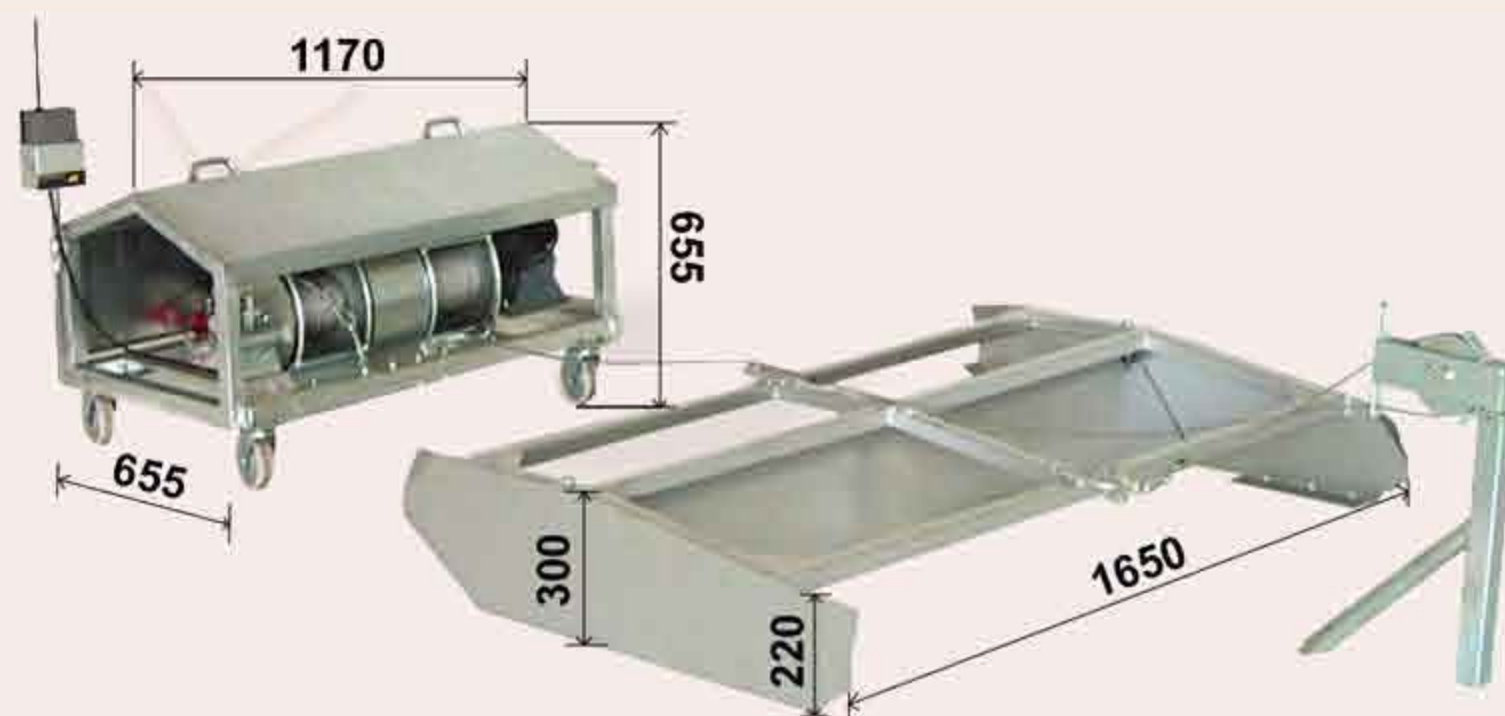



TECNIIEQUIP ANIMAL S.L.



RAGLAGE DOBLE PALA

RAGLAGE CUADRO 1 LINEA



Polea de soporte
Support pulley
Poulie de support



Motor y polea
Motor and pulley
Moteur et poulie



Cuadro electrico
1 Linea
Electrical frame
1 Pit



Final de carrera
Final career



Chaise
Case

RAGLAGE CUADRO 4 LINEAS



MANDO CONTROL
REMOTO CUADRO
ELECTRICO 4 FOSAS

REMOTE CONTROL
ELECTRICAL FRAME
4 PITS



CUADRO ELECTRICO AUTOMATICO
4 FOSAS RAGLAGE CON CONTROL
EVACUACION DE EXCREMENTOS

AUTOMATIC ELECTRICAL FRAME
4 PITS RAGLAGE WITH EXCREMENTS
EVACUATION CONTROL



DISPOSITIVO DE
PARO-CONTROL
FINAL CARRERA
RAGLAGE

DEVICE STOP-CONTROL
FINAL CAREER
RAGLAGE

RAGLAGE

Sistema automatizado de limpieza de fosas en granjas cunicola.

Este sistema puede tener varias palas de arrastre, dependiendo de la cantidad y longitud de la fosa. Estan unidas a un motor reductor por medio de un cable. Elementos del sistema automatizado de limpieza RAGLAGE:

- Palas de arrastre de doble lamina.
- Poleas de soporte, pueden ser horizontales o verticales y estan fijadas al suelo.
- Cuadro electrico.
- Cable de arrastre de 6mm de diam. en acero galva. y enfundado en plástico.
- Motor de 0,75CV a 380V trifásico.

RAGLAGE

Automated system of pit cleaning in rabbit farms. This system can have several excavator scraper, depending the amount and lenght of the pit. They are connected to a motor reducer trough a cable.

Elements of the automated cleaning system RAGLAGE:

- Scraper excavators double blade.
- Support pulleys, can be horizontal or vertical, and are fixed to the floor.
- Electrical frame.
- Drag cable of 6mm diameter in galvanized steel and sheathe in plastic.
- 380V three-phase motor of 0.75 HP.

RAGLAGE

Système automatisé pour l'évacuation des lisiers des fosses. Ce principe peut accepter plusieurs racleurs suivant la longueur des fosses. L'entraînement à partir du moteur est assuré par un câble.

Éléments composant le système RAGLAGE de nettoyage automatisé:

- Racleurs à double lame.
- Poulies de support fixées au sol positionnées indépendanmemnt en position verticale ou horizontale.
- Boîtier électrique.
- Câble d'entraînement de 6mm de diamètre en acier galvanisé enrobé de plastique.
- Moteur de 0,75 CV (380 triphasé).

RAGLAGE

Sistema automatizado da limpeza do cunicola das sepulturas nas fazendas.

Este sistema pode ter diversos excavators, depender a quantidade e comprimento da trincheira na sepultura. Estan junto com um motor reduzindo-se por meio de um cabo. Elementos do sistema automatizado da limpeza RAGLAGE:

- O dobro da sustentação Lamina.
- Poleas dos excavators da trincheira, pode ser fixo horizontal ou vertical e estan à terra.
- Retrato do electrico.
- Cabo do arrasto 6mm do diam. no aço galva. e contido no plástico.
- Motor de 0,75CV three-phase a 380V..



TECNIQUIP ANIMAL S.L.



Alimentación desplazada



Alimentación central

**E.3 MODULO MEGA B 12/3-T F2000
ALIMENTACION CENTRAL**

ACCESORIOS



Ref. 3.4550
Comedero 4 doble



Ref. 3.4551
Supl. comedero



Ref. 3.4552
Delantero nido 40



Ref. 3.4553
Trampilla nido



Ref. 3.4554
Tramp. nido gatera



Ref. 3.3840
Cuna profunda



Ref. 3.4555
Nido cuna 40



Ref. 3.4557
Nido 40



Ref. 3.3792
Rejilla sandwich



Ref. 3.4558
Curapatas



Ref. 3.4576
Caña para 6 minis



Ref. 3.4568
Caña 6 chupetes



Ref. 3.4559
Protector orines



Ref. 3.4584
Tapa nido 40



Ref. 3.5128
Deposito reg. 8 l.



Ref. 3.525
Tolva cuadruple alta



Ref. 3.526
Tolva cuadruple baja

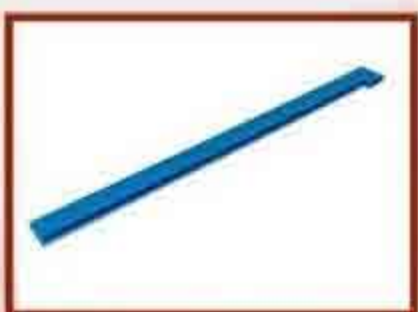

Ref. 3.4589
Perfil escuadra
sup. azul



Ref. 46.1023
13x16cm.
Portafichas con ficha
control

MODULO MEGA B 12/3-T ALIMENTACION CENTRAL AUTOMATICA - 12 Departamentos.

Todo el material metálico utilizado (alambre, chapa y tubo) es galvanizado de alta calidad, como es norma en Tecniequip. Los materiales plásticos son vírgenes y **no tóxicos**. Módulos polivalentes únicos en el mercado, de fácil adaptación a cualquier manejo. Con alimentación desplazada automática, para facilitar la extracción del comedero y lactancia manual o automática (opcional). Doble pie para estacionamiento de motor y tolva, evitando vibraciones. Comederos diseñados para el mejor aprovechamiento del alimento y para alimentación diferenciada (opcional), eliminando pérdidas.

La empresa no se hace responsable en caso de no utilizar con los equipos, materiales originales Tecniequip. El precio del modulo es sin accesorios (en la fotografía esta con accesorios).

MEDIDAS

INTERIOR DEPARTAMENTO 400x1000x310

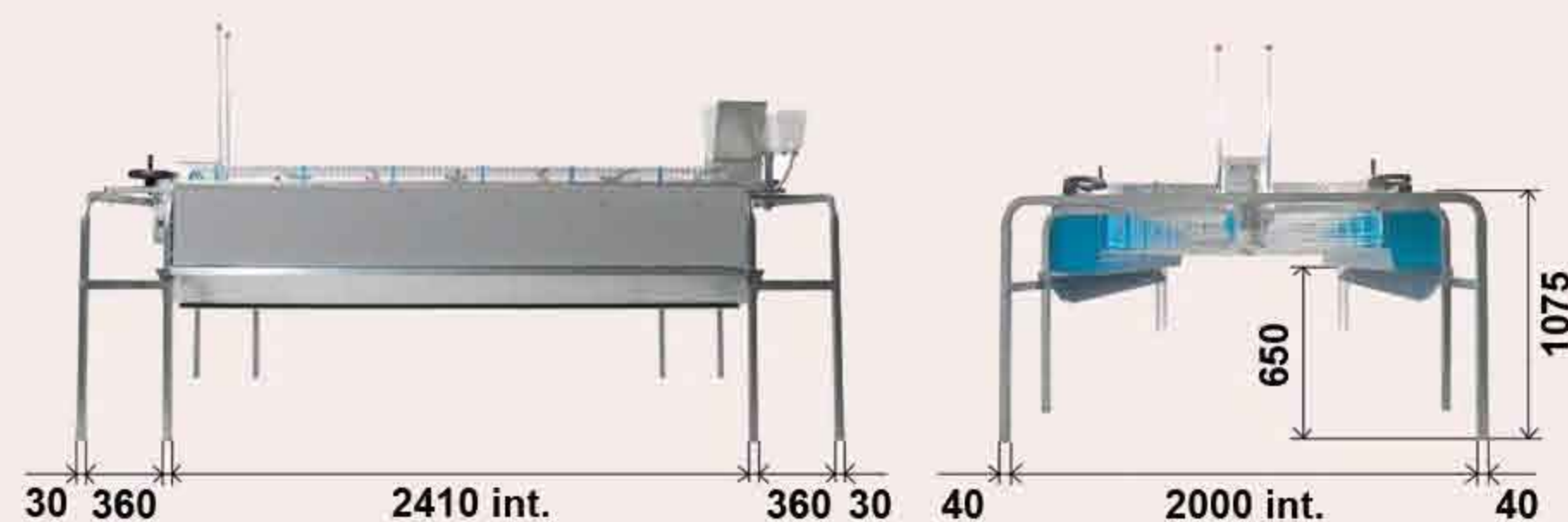



TECNIQUIP ANIMAL S.L.

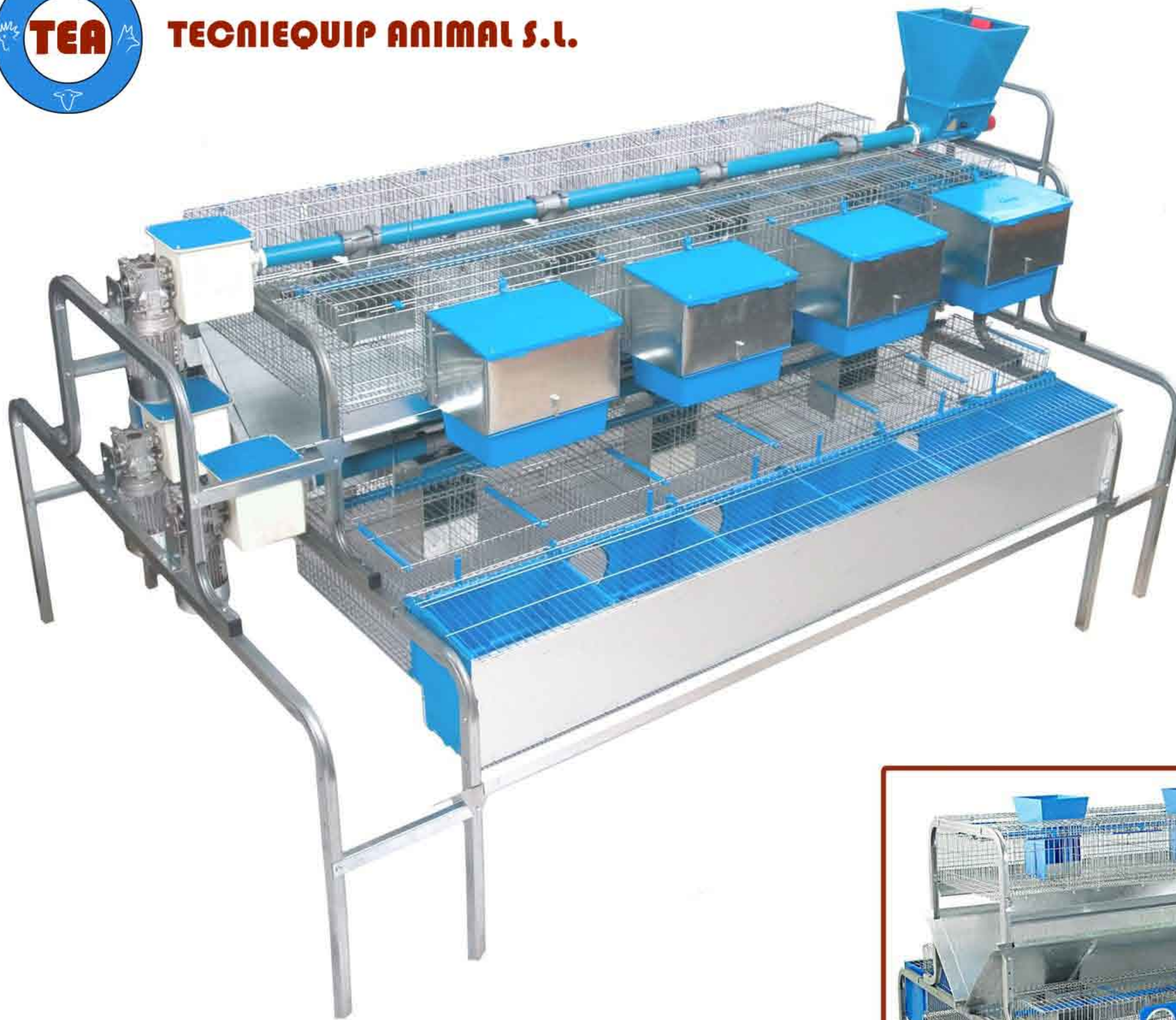

**E.3 MODULO MEGA BABY 12/16 6/4-T F2000
CON ALIMENTACION AUTOMATICA**

ACCESORIOS



Ref. 3.4550
Comedero 4 doble



Ref. 3.4551
Supl. comedero



Ref. 3.4552
Delantero nido 40



Ref. 3.4553
Trampilla nido



Ref. 3.4554
Tramp. nido gatera



Ref. 3.3840
Cuna profunda



Ref. 3.4555
Nido cuna 40



Ref. 3.4557
Nido 40



Ref. 3.3792
Rejilla sandwich



Ref. 3.4558
Curapatas



Ref. 3.4559
Protector orines



Ref. 3.4568
Caña 6 chupetes



Ref. 3.4570
Caña 8 chupetes



Ref. 3.806
Nido universal



Ref. 3.5128
Deposito reg. 8 l.



Ref. 3.4561
Comedero 2 interior



Ref. 3.525
Tolva cuadruple alta



Ref. 3.526
Tolva cuadruple baja



Ref. 3.4584
Tapa nido 40

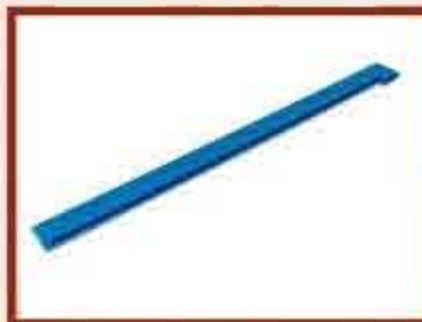

Ref. 3.4589
Perfil escuadra
sup. azul

MODULO MEGA BABY 12/16-T 28 Departamentos.

Todo el material metálico utilizado (alambre, chapa y tubo) es galvanizado de alta calidad, como es norma en Tecniequip. Los materiales plásticos son vírgenes y **no tóxicos**. Módulos polivalentes únicos en el mercado, de fácil adaptación a cualquier manejo, con alimentación y lactancia, semi-automática o automática. Con piso superior para reposición, gestación o sobre-ocupación (con nidos adaptables), mejorando el aprovechamiento del espacio. Piso inferior también polivalente (madres, engorde o machos). Comederos diseñados para el mejor aprovechamiento del alimento y para alimentación diferenciada (opcional), eliminando pérdidas.

La empresa no se hace responsable en caso de no utilizar con los equipos, materiales originales Tecniequip. El precio del modulo es sin accesorios (en la fotografía esta con accesorios).

MEDIDAS

INTERIOR DEPARTAMENTO inferior 400x900x310
superior 300x430x310

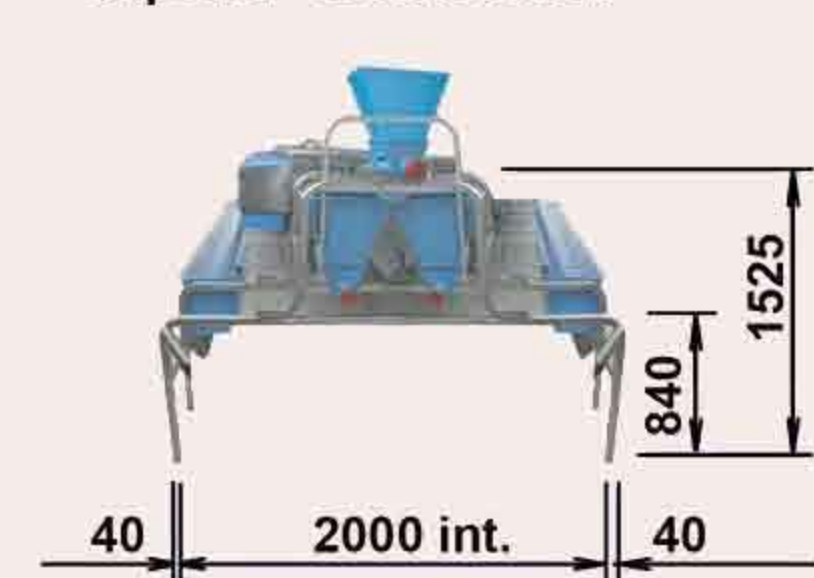
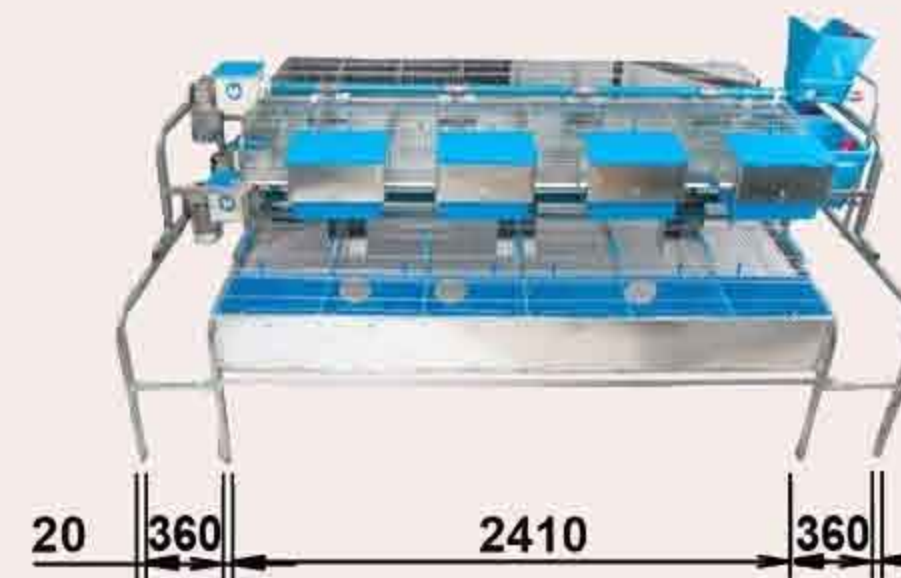



TECNIIEQUIP ANIMAL S.L.



E.3 MODULO CUNI BABY 48/12-T F2000

ACCESORIOS



Ref. 3.4550
Comedero 4 doble



Ref. 3.4551
Supl. comedero



Ref. 3.4570
Caña 8 chupetes



Ref. 3.4559
Protector orines



Ref. 3.5128
Deposito reg. 8 l.



Ref. 3.525
Tolva cuadruple alta



Ref. 3.526
Tolva cuadruple baja



Ref. 3.4558
Curapatas



Ref. 3.4589
Perfil escuadra
sup. azul



Ref. 46.1023
13x16cm.
Portafichas con ficha
control

MODULO CUNI BABY - 48/12-T 48 Departamentos.

Todo el material metálico utilizado (alambre, chapa y tubo) es galvanizado de alta calidad, como es norma en Tecniequip. Los materiales plásticos son vírgenes y **no tóxicos**. Módulos polivalentes (Reposición, Gestación, Sobre-ocupación "con nido adaptable opcional" o Engorde "2 gazapos"). Adaptables a alimentación automática (opcional). Comederos diseñados para el mejor aprovechamiento del alimento con suplemento tolva para el aumento de capacidad (opcional), eliminando perdidas. Módulos en dos pisos para un mejor aprovechamiento del espacio.

La empresa no se hace responsable en caso de no utilizar con los equipos, materiales originales Tecniequip. El precio del modulo es sin accesorios (en la fotografía esta con accesorios).

MEDIDAS

INTERIOR DEPARTAMENTO 300x430x310

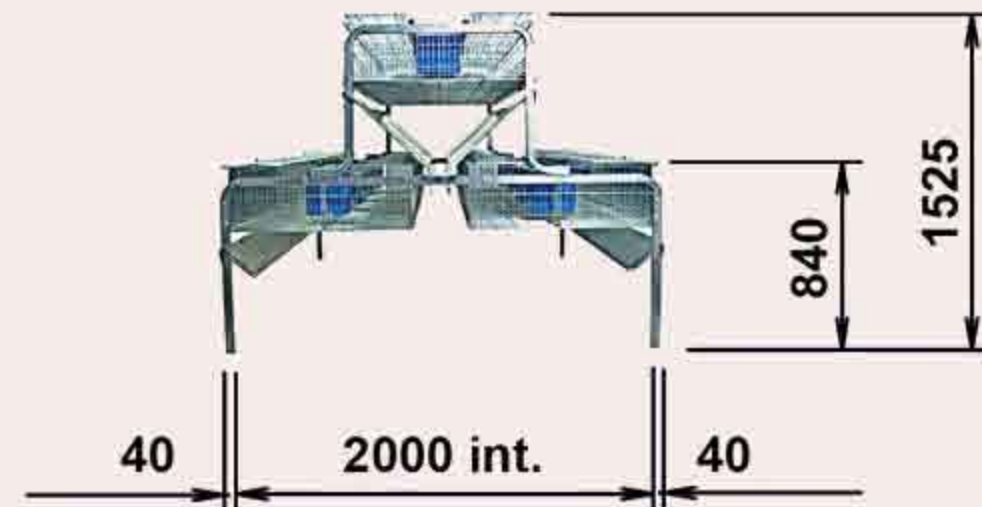
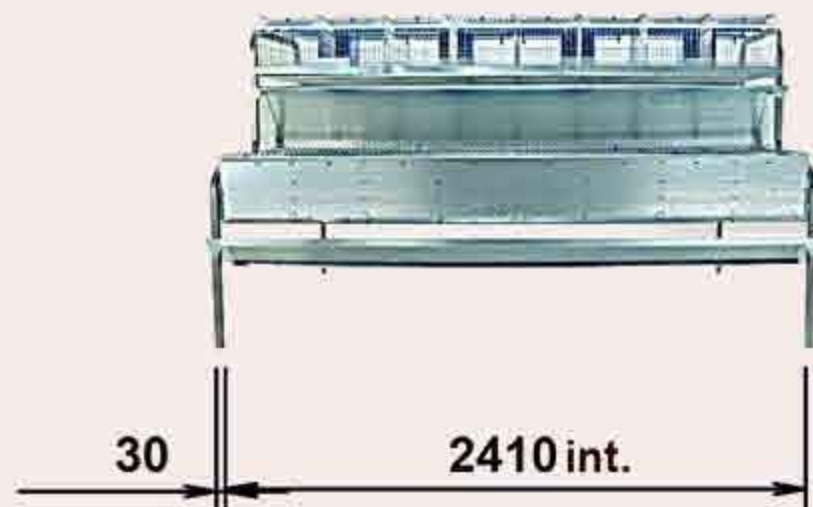



TECNIEQUIP ANIMAL S.L.



**E.3 MODULO CUNI BABY 32/8-T
F2000/F1800**



**E.3 MODULO CUNI BABY
16/4-T F900**

ACCESORIOS



Ref. 3.4550
Comedero 4 doble



Ref. 3.4551
Supl. comedero



Ref. 3.4558
Curapatas



Ref. 3.4570
Caña 8 chupetes



Ref. 3.4559
Protector orines



Ref. 3.5128
Deposito reg. 8 l.



Ref. 3.525
Tolva cuadruple alta



Ref. 3.526
Tolva cuadruple baja

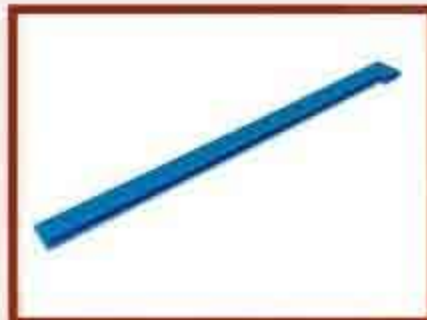

Ref. 3.4589
Perfil escuadra
sup. azul



Ref. 46.1023
13x16cm.
Portafichas con ficha
control

MODULO CUNI BABY 32/8-T 32 Departamentos. CUNI BABY 16/4-T 16 Departamentos.
Todo el material metálico utilizado (alambre, chapa y tubo) es galvanizado de alta calidad, como es norma en Tecniequip. Los materiales plásticos son vírgenes y **no tóxicos**. Módulos polivalentes (Reposición, Gestación, Sobre-ocupación "con nido adaptable opcional" o engorde "2 gazapos").
Adaptables a alimentación automática (opcional).
Comederos diseñados para el mejor aprovechamiento del alimento con suplemento tolva para el aumento de capacidad (opcional), eliminando pérdidas.

La empresa no se hace responsable en caso de no utilizar con los equipos, materiales originales Tecniequip. El precio del modulo es sin accesorios (en la fotografía esta con accesorios).

MEDIDAS

INTERIOR DEPARTAMENTO 300x430x310

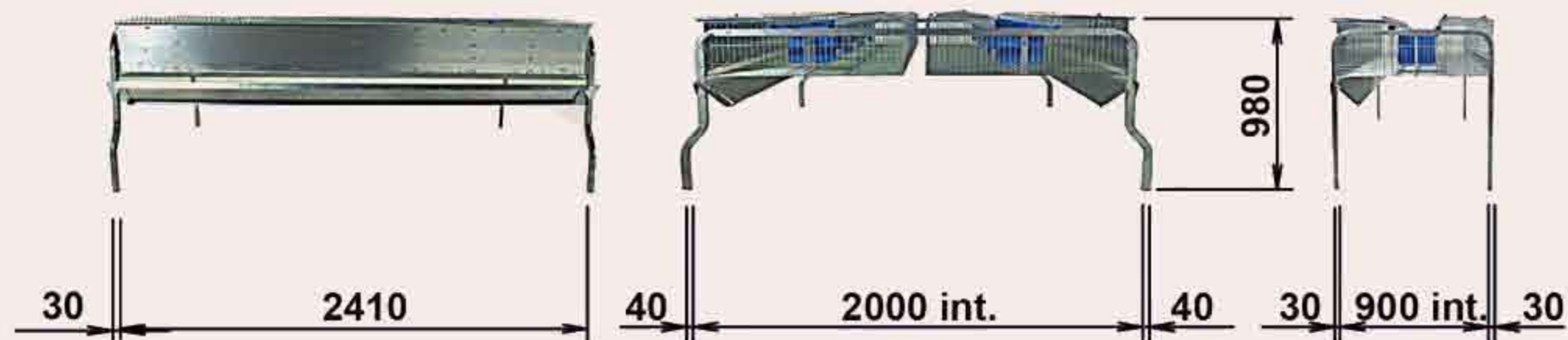



TECNIEQUIP ANIMAL S.L.

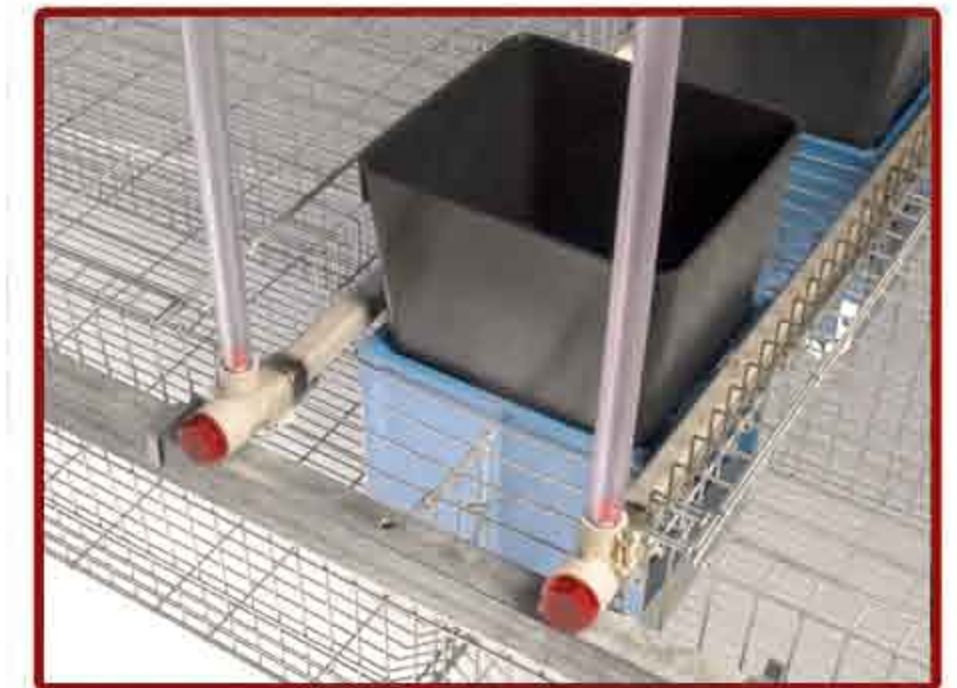

**E.3 MODULO CUNI ENGORDE
10/5-T F2000**

ACCESORIOS



Ref. 3.4550
Comedero 4 doble



Ref. 3.4551
Sup. comedero



Ref. 3.4576
Caña para 6 minis



Ref. 3.4568
Caña 6 chupetes



Ref. 3.4559
Protector orines



Ref. 3.5128
Deposito reg. 8 l.



Ref. 3.525
Tolva cuadruple alta



Ref. 3.526
Tolva cuadruple baja

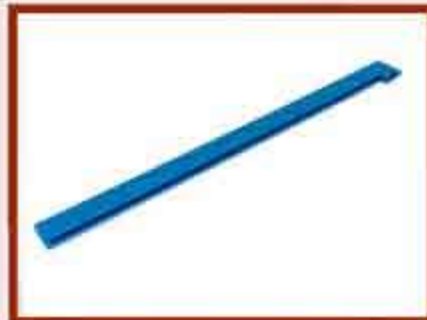

Ref. 3.4589
Perfil escuadra
sup. azul



Ref. 46.1023
13 x 16cm.
Portafichas con ficha
control

MODULO CUNI ENGORDE 10/5-T 12 Departamentos.

Todo el material metálico utilizado (alambre, chapa y tubo) es galvanizado de alta calidad, como es norma en Tecniequip. Los materiales plásticos son vírgenes y **no tóxicos**. Modulo con jaulas de gran capacidad y fácil limpieza para conejos de engorde. Adaptables a alimentación automática (opcional). Comederos diseñados para el mejor aprovechamiento del alimento, con suplemento tolva para el aumento de capacidad (opcional), eliminando perdidas.

La empresa no se hace responsable en caso de no utilizar con los equipos, materiales originales Tecniequip. El precio del modulo es sin accesorios (en la fotografia esta con accesorios).

MEDIDAS

INTERIOR DEPARTAMENTO Ref. 40.12002 400x1000x310

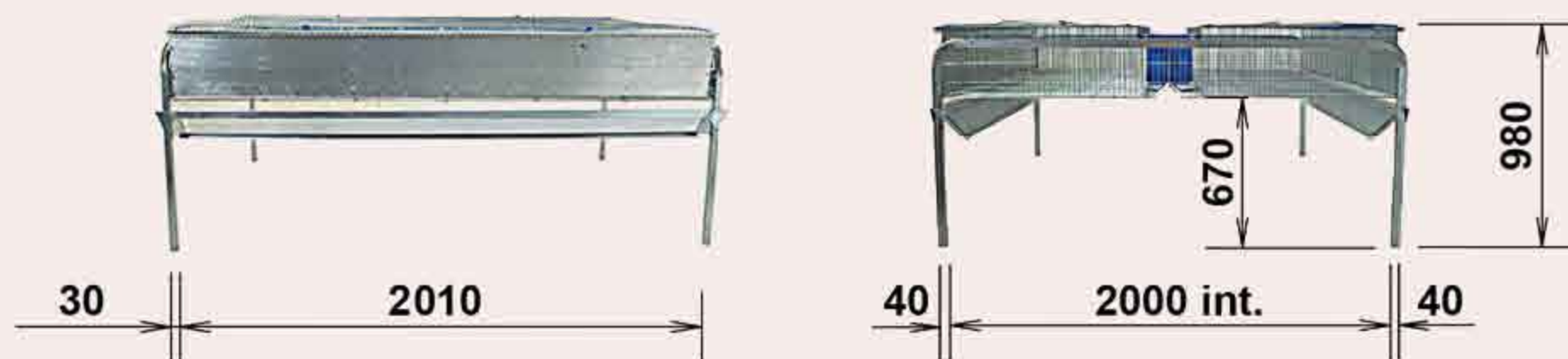



TECNIIEQUIP ANIMAL S.L.



**E.3 MODULO CUNI ENGORDE
12/6-T F2000**

ACCESORIOS



Ref. 3.4550
Comedero 4 doble



Ref. 3.4551
Sup. comedero



Ref. 3.4576
Caña para 6 minis



Ref. 3.4568
Caña 6 chupetes



Ref. 3.4559
Protector orines

MODULO CUNIENGORDE 12/6-T 12 departamentos.

Todo el material metálico utilizando (alambre, chapa y tubo) es galvanizado de alta calidad, como es norma en Tecniequip. Los materiales plásticos son vírgenes y no tóxicos. Módulo con jaulas de gran capacidad y fácil limpieza para conejos de engorde. Adaptables a alimentación automática (opcional). Comederos diseñados para el mejor aprovechamiento del alimento, con suplemento tolva para el aumento de capacidad (opcional), eliminando pérdidas.

La empresa no se hace responsable en caso de no utilizar con los equipos, materiales originales Tecniequip. El precio del módulo es sin accesorios (en la fotografía esta con accesorios).



Ref. 3.5128
Deposito reg. 8 l.



Ref. 3.525
Tolva cuadruple alta



Ref. 3.526
Tolva cuadruple baja



Ref. 3.4589
Perfil escuadra
sup. azul



Ref. 46.1023
13 x 16cm.
Portafichas con ficha
control

MEDIDAS

INTERIOR DEPARTAMENTO Ref. 40.12002 400x1000x310

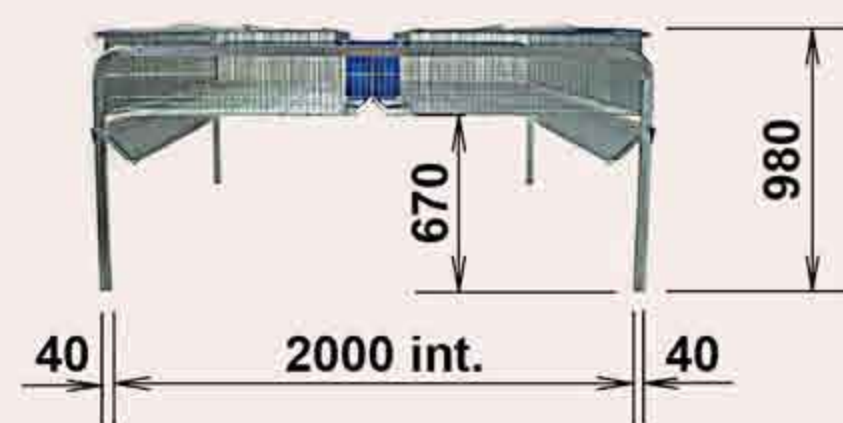
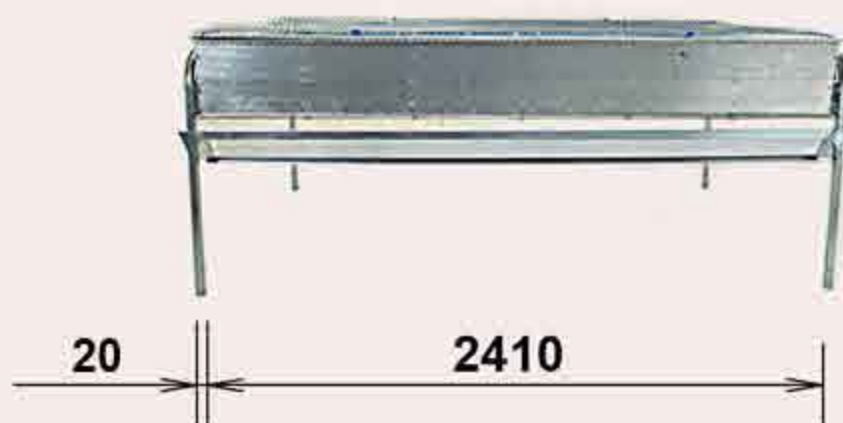



TECNIQUIP ANIMAL S.L.



**JAULA POLIVALENTE PARA MATERNIDAD, ENGORDE Y MACHOS
E.3 MODULO ECUS 1**



Ref. 3.4902
Tolva M.2.



Ref. 3.404070
Caña mini 5



Ref. 40.7626
Protector orines



Ref. 3.404071
Caña mini 5+5



Ref. 3.3840
Cuna profunda

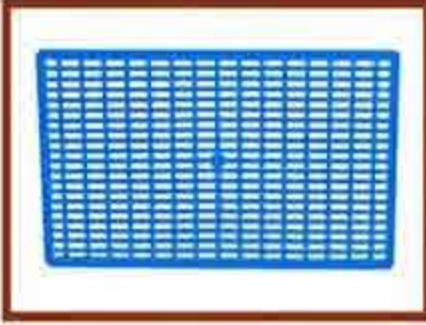

Ref. 3.3792
Rejilla Sandwich



Ref. 40.311
Curapatas Relax



Ref. 3.5128
Deposito reg. 8L.

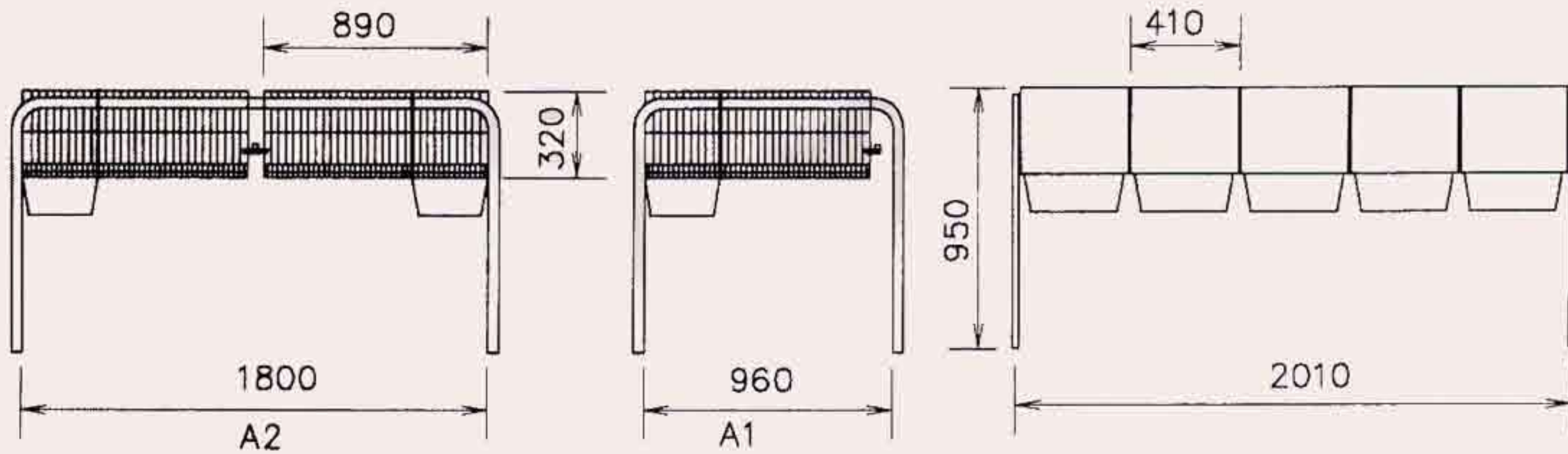



TECNIIEQUIP ANIMAL S.L.



**E.3 MODULO MEGA EUROPEA 12/3-T F2000
CON ALIMENTACION AUTOMATICA**

ACCESORIOS



Ref. 3.4550
Comedero 4 doble



Ref. 3.4551
Supl. comedero



Ref. 3.4552
Delantero nido 40



Ref. 3.4553
Trampilla nido



Ref. 3.4554
Tramp. nido gatera



Ref. 3.3840
Cuna profunda



Ref. 3.4555
Nido cuna 40



Ref. 3.4557
Nido 40



Ref. 3.3792
Rejilla sandwich



Ref. 3.4558
Curapatas



Ref. 3.4559
Protector orines

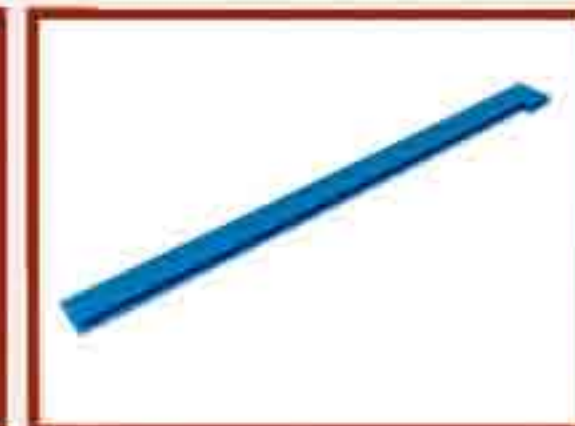

Ref. 3.4589
Perfil escuadra
sup. azul



Ref. 3.4582
Kit descanso varilla



Ref. 3.4568
Caña 6 chupetes



Ref. 46.1023
13 x 16cm.
Portafichas con ficha
control



Ref. 3.5128
Deposito reg. 8 l.



Ref. 3.525
Tolva cuadruple alta



Ref. 3.526
Tolva cuadruple baja

MODULO MEGA EUROPEA 12/3-T 12 Departamentos.

Todo el material metálico utilizado (alambre, chapa y tubo) es galvanizado de alta calidad, como es norma en Tecniequip. Los materiales plásticos son vírgenes y no tóxicos. Módulos polivalentes únicos en el mercado, de fácil adaptación a cualquier manejo. Adaptables a cualquier automatismo de alimentación y lactancia controlada (opcionales). Comederos diseñados para el mejor aprovechamiento del alimento y para alimentación diferenciada (opcional), eliminando pérdidas. Dotada con espacio relax, para el reposo del animal.

La empresa no se hace responsable en caso de no utilizar con los equipos, materiales originales Tecniequip. El precio del modulo es sin accesorios (en la fotografía esta con accesorios).

MEDIDAS

INTERIOR DEPARTAMENTO 400x1000x595

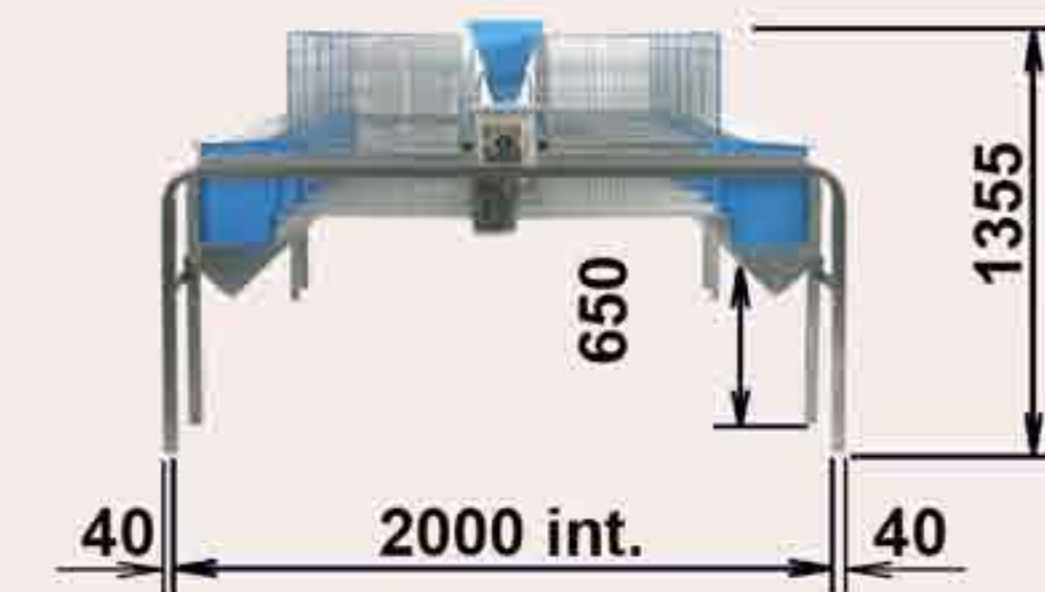
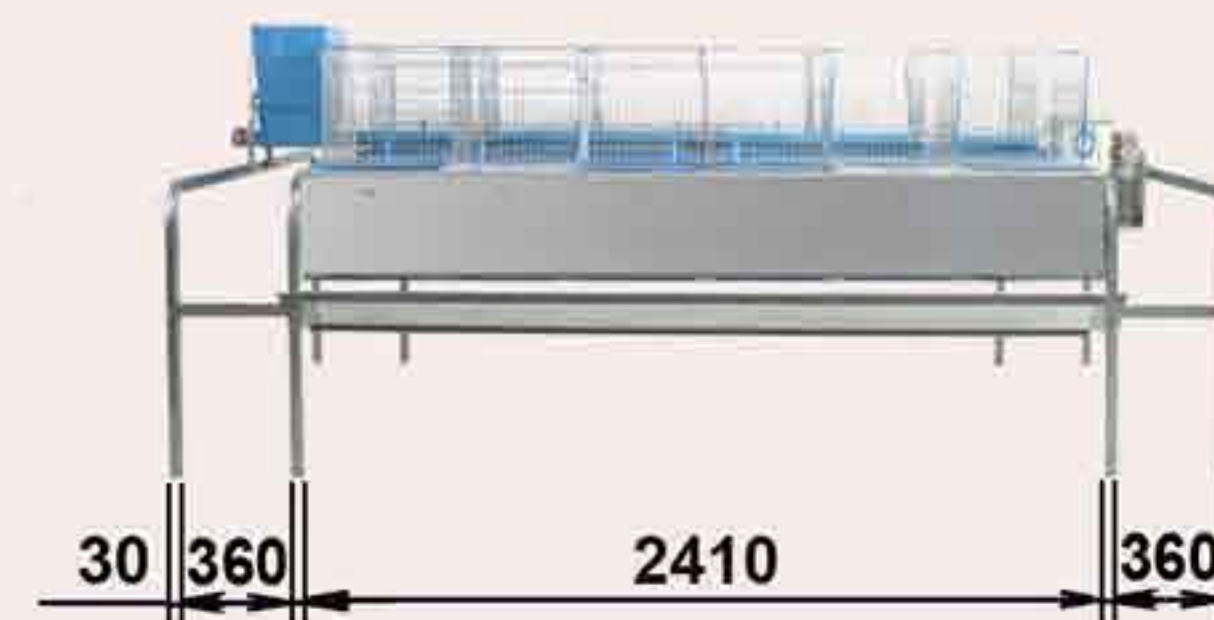



TECNIQUIP ANIMAL S.L.



**E.3 MODULO CUNIMATIC B 12/3-T F1800
SUPLEMENTO COMEDERO**

ACCESORIOS



Ref. 3.4550
Comedero 4 doble



Ref. 3.4551
Supl. comedero

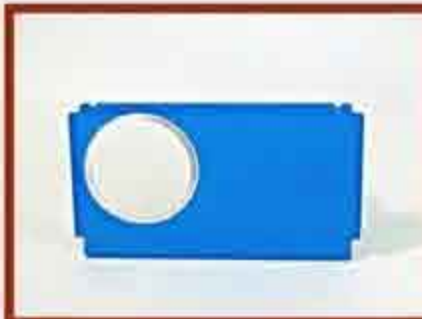

Ref. 3.4552
Delantero nido 40



Ref. 3.4553
Trampilla nido



Ref. 3.4554
Tramp. nido gatera



Ref. 3.3840
Cuna profunda



Ref. 3.4555
Nido cuna 40



Ref. 3.4557
Nido 40



Ref. 3.3792
Rejilla sandwich



Ref. 3.4558
Curapatas



Ref. 3.4576
Caña para 6 minis



Ref. 3.4568
Caña 6 chupetes



Ref. 3.4559
Protector orines



Ref. 3.4584
Tapa nido 40



Ref. 3.5128
Deposito reg. 8 l.



Ref. 3.525
Tolva cuadruple alta



Ref. 3.526
Tolva cuadruple baja

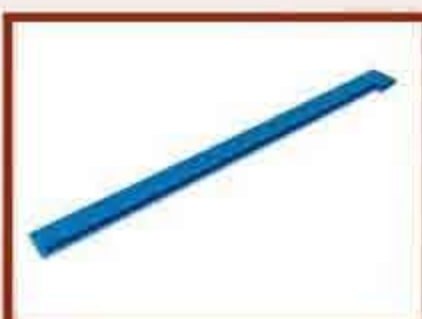

Ref. 3.4589
Perfil escuadra
sup. azul



Ref. 46.1023
13x16cm.
Portafichas con ficha
control

MODULO CUNIMATIC B 12/3-T. 12 Departamentos.

Todo el material metálico utilizado (alambre, chapa y tubo) es galvanizado de alta calidad, como es norma en Tecniequip. Los materiales plásticos son vírgenes y no tóxicos. Módulos polivalentes únicos en el mercado, de fácil adaptación a cualquier manejo. Adaptables a cualquier automatismo de alimentación y lactancia controlada (opcionales). Comederos diseñados para el mejor aprovechamiento del alimento y para alimentación diferenciada (opcional), eliminando perdidas.

La empresa no se hace responsable en caso de no utilizar con los equipos, materiales originales Tecniequip. El precio del modulo es sin accesorios (en la fotografía esta con accesorios).

MEDIDAS

INTERIOR DEPARTAMENTO 400x1000x310





TECNI EQUIP ANIMAL S.L.



E.3 MODULO CUNIMATIC 6/3-T
Ref. 45.12031

ACCESORIOS



Ref. 3.4561
Comedero 2 interior



Ref. 3.4557
Nido 40



Ref. 3.4037
Bebe. mini manguera



Ref. 3.4553
Trampilla nido



Ref. 3.4554
Tramp. nido gatera

JAULA CUNIMATIC 6/3-T

Todo el material metálico utilizado (alambre, chapa y tubo) es galvanizado de alta calidad, como es norma en Tecniequip. Los materiales plásticos son vírgenes y **no tóxicos**. Módulos polivalentes únicos en el mercado, de fácil adaptación a cualquier manejo, con alimentación y lactancia, semi-automática o automática. Con piso superior para reposición, gestación o sobre-ocupación (con nidos adaptables), mejorando el aprovechamiento del espacio. Piso inferior también polivalente (madres, engorde o machos). Comederos diseñados para el mejor aprovechamiento del alimento y para alimentación diferenciada (opcional), eliminando pérdidas.

La empresa no se hace responsable en caso de no utilizar con los equipos, materiales originales Tecniequip. El precio del modulo es sin accesorios (en la fotografía esta con accesorios).



Ref. 3.4584
Tapa nido 40



Ref. 3.4558
Curapatas



Ref. 3.1054
Bebe. mini botella



Ref. 90.8738
Grapadora manual



Ref. 3.4562
Caña 4 chupetes



Ref. 3.5078
Depósito regulador 5L. con racord 10/14



Ref. 46.1023
13x16cm.
Portafichas con ficha control



Ref. 46.7024
Paleta repartidora de pienso 25x12x14 cm.



Ref. 90.7044
Muelle de cierre 7cm.

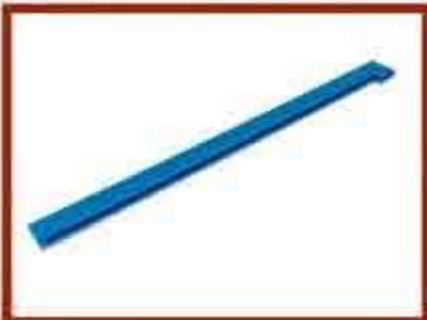

Ref. 3.4589
Perfil escuadra sup. azul.



Ref. 3.4552
Delantero nido 40



Ref. 3.3792
Rejilla sandwich



Ref. 3.3840
Cuna profunda



Ref. 3.4555
Nido cuna 40



Ref. 3.5128
Deposito reg. 8 l.

MEDIDAS

INTERIOR DEPARTAMENTO 900 X 400 X 310

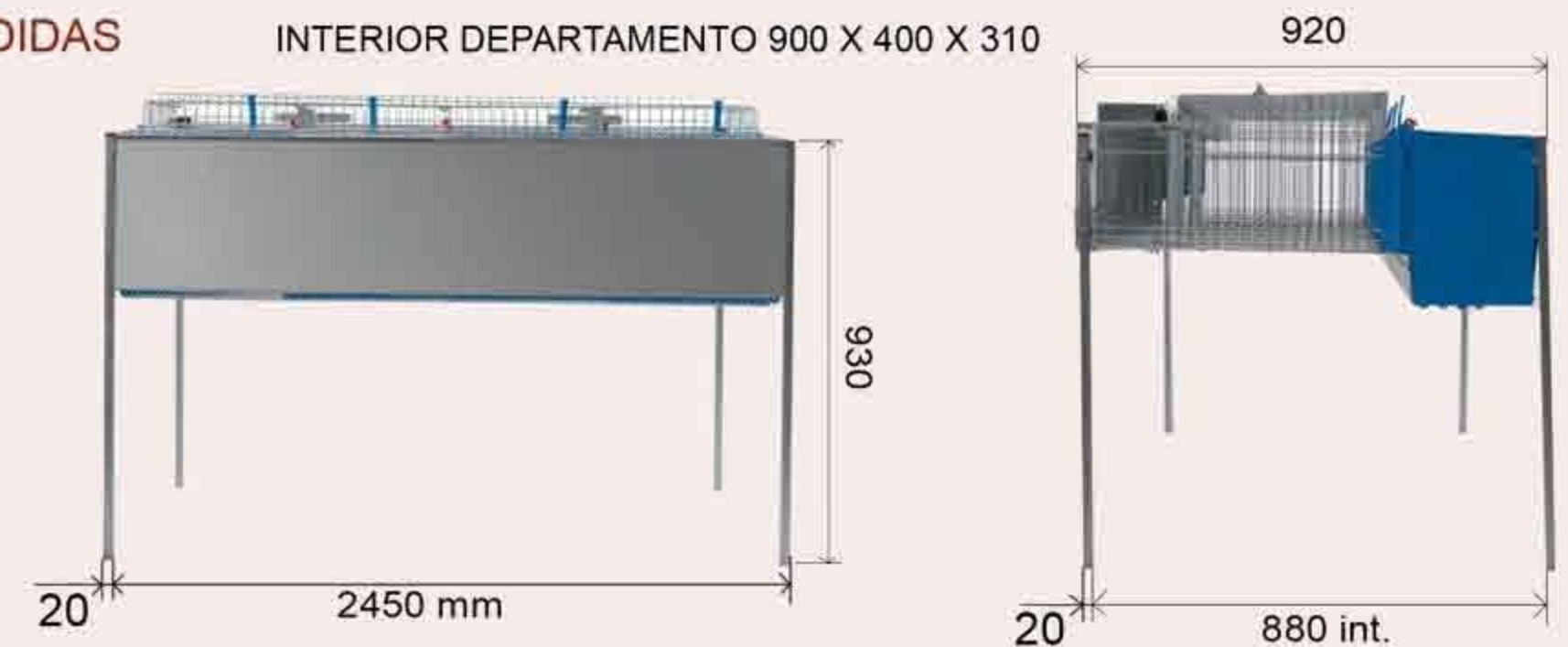



TECNI EQUIP ANIMAL S.L.



E.3 JAULA CUNIMATIC 4/2-T
Ref. 40.12032

ACCESORIOS



Ref. 3.4561
Comedero 2 interior



Ref. 3.4557
Nido 40



Ref. 3.4037
Bebe. mini manguera



Ref. 3.4553
Trampilla nido



Ref. 3.4554
Tramp. nido gatera



Ref. 3.4584
Tapa nido 40



Ref. 3.4558
Curapatas



Ref. 3.1054
Bebe. mini botella



Ref. 90.8738
Grapadora manual



Ref. 3.4562
Caña 4 chupetes



Ref. 3.5078
Depósito regulador 5L. con racord 10/14



Ref. 46.1023
13x16cm.
Portafichas con ficha control



Ref. 46.7024
Paleta repartidora de pienso 25x12x14 cm.



Ref. 90.7044
Muelle de cierre 7cm.

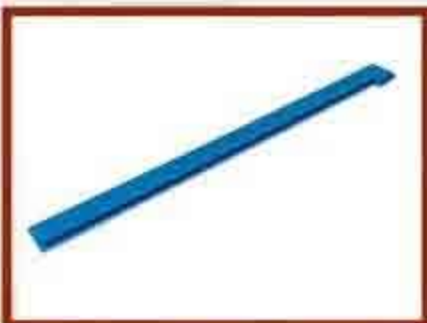

Ref. 3.4589
Perfil escuadra sup. azul.



Ref. 3.4552
Delantero nido 40



Ref. 3.3792
Rejilla sandwich



Ref. 3.3840
Cuna profunda



Ref. 3.4555
Nido cuna 40



Ref. 3.5128
Deposito reg. 8 l.

JAULA CUNIMATIC 4/2-T

Todo el material metálico utilizado (alambre, chapa y tubo) es galvanizado de alta calidad, como es norma en Tecniequip. Los materiales plásticos son vírgenes y **no tóxicos**. Módulos polivalentes únicos en el mercado, de fácil adaptación a cualquier manejo, con alimentación y lactancia, semi-automática o automática. Con piso superior para reposición, gestación o sobre-ocupación (con nidos adaptables), mejorando el aprovechamiento del espacio. Piso inferior también polivalente (madres, engorde o machos). Comederos diseñados para el mejor aprovechamiento del alimento y para alimentación diferenciada (opcional), eliminando pérdidas.

La empresa no se hace responsable en caso de no utilizar con los equipos, materiales originales Tecniequip. El precio del modulo es sin accesorios (en la fotografía esta con accesorios).

MEDIDAS

INTERIOR DEPARTAMENTO 900 X 400 X 310





TECNIQUEQUIP ANIMAL S.L.



E.3 JAULA CUNIMATIC 4/3
Ref. 40.12034

ACCESORIOS



Ref. 3.4561
Comedero 2 interior



Ref. 3.4557
Nido 40



Ref. 3.4037
Bebe. mini manguera



Ref. 3.4553
Trampilla nido



Ref. 3.4554
Tramp. nido gatera



Ref. 3.4584
Tapa nido 40



Ref. 3.4558
Curapatas



Ref. 3.1054
Bebe. mini botella



Ref. 3.4565
Caña 3 chupetes



Ref. 3.4562
Caña 4 chupetes



Ref. 3.5078
Depósito regulador
5L. con racord 10/14



Ref. 46.1023
13x16cm.
Portafichas con ficha
control



Ref. 3.4579
Comedero 2 aldaba



Ref. 90.7044
Muelle de cierre
7cm.

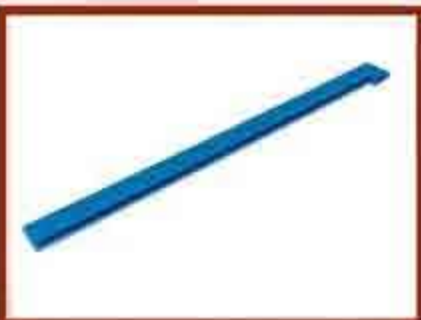

Ref. 3.4589
Perfil escuadra
sup. azul.



Ref. 3.4552
Delantero nido 40



Ref. 3.3792
Rejilla sandwich



Ref. 3.3840
Cuna profunda



Ref. 3.4555
Nido cuna 40



Ref. 3.5128
Deposito reg. 8 l.

JAULA CUNIMATIC 4/3

Todo el material metálico utilizado (alambre, chapa y tubo) es galvanizado de alta calidad, como es norma en Tecniequip. Los materiales plásticos son vírgenes y **no tóxicos**. Módulos polivalentes únicos en el mercado, de fácil adaptación a cualquier manejo, con alimentación y lactancia, semi-automática o automática. Con piso superior para reposición, gestación o sobre-ocupación (con nidos adaptables), mejorando el aprovechamiento del espacio. Piso inferior también polivalente (madres, engorde o machos). Comederos diseñados para el mejor aprovechamiento del alimento y para alimentación diferenciada (opcional), eliminando pérdidas.

La empresa no se hace responsable en caso de no utilizar con los equipos, materiales originales Tecniequip. El precio del modulo es sin accesorios (en la fotografía esta con accesorios).

MEDIDAS INTERIOR DEPARTAMENTO Superior 553 x 600 x 310 Inferior 900 x 400 x 310

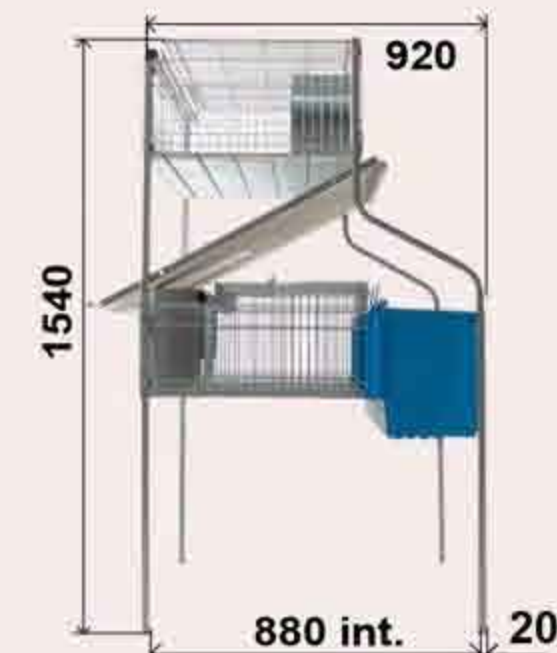
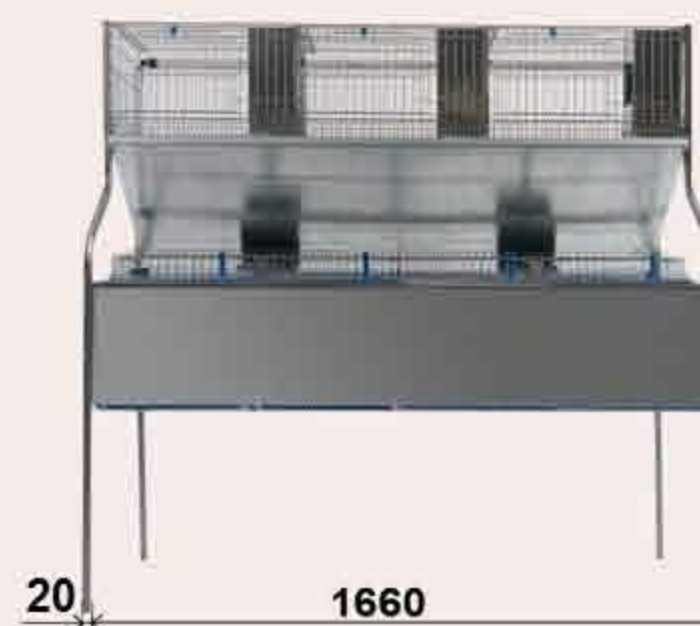



TECNIIEQUIP ANIMAL S.L.

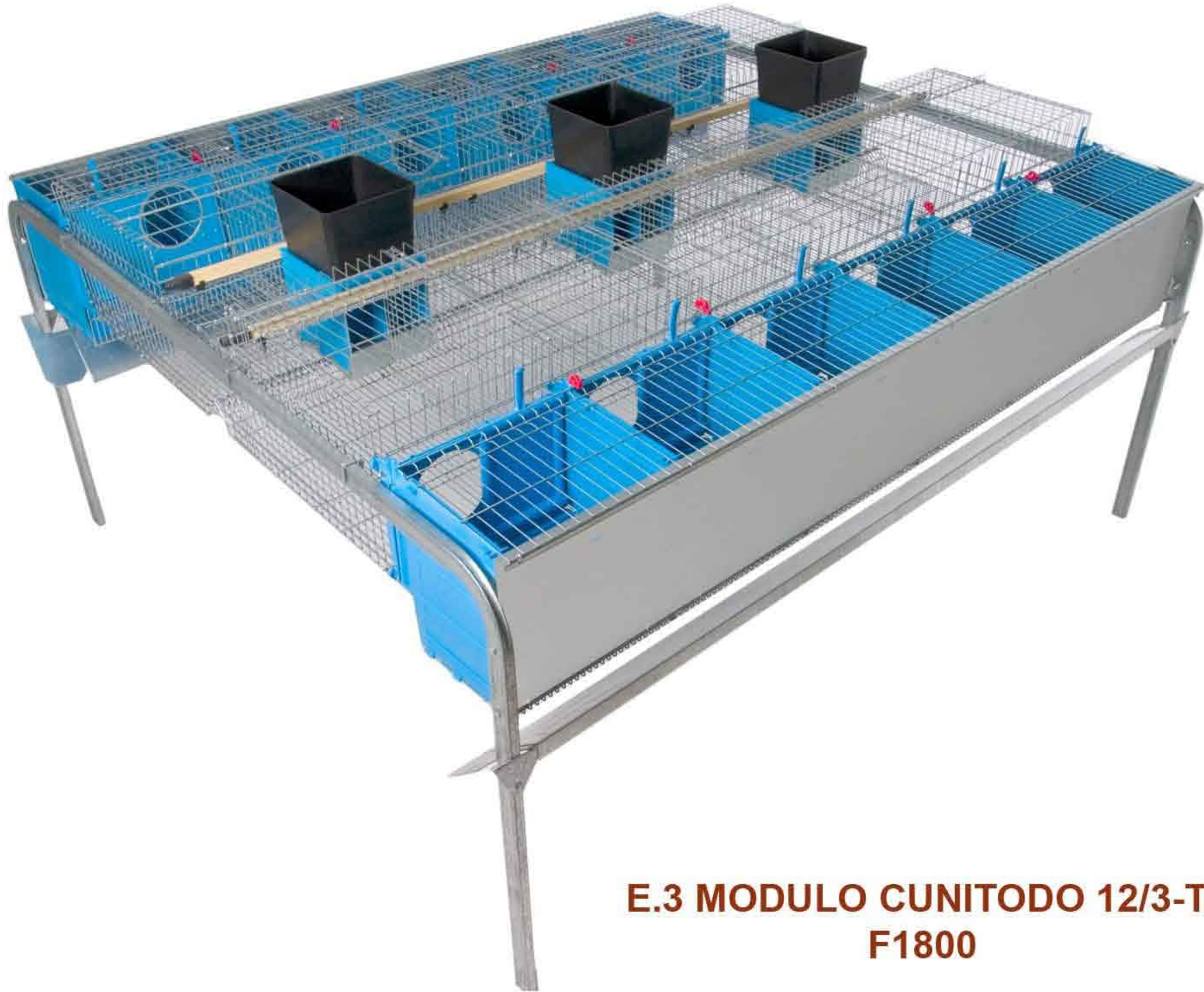

**E.3 MODULO CUNITODO 12/3-T
F1800**

ACCESORIOS



Ref. 3.4550
Comedero 4 doble



Ref. 3.4551
Supl. comedero



Ref. 3.4560
Delantero nido 34



Ref. 3.4553
Trampilla nido



Ref. 3.4554
Tramp. nido gatera



Ref. 3.4594
Protector orines



Ref. 3.4592
Caña 6 chupetes



Ref. 3.4556
Nido 34 azul



Ref. 3.4600
Caña para 6 minis



Ref. 3.4558
Curapatas



Ref. 3.5128
Deposito reg. 8 l.



Ref. 3.4583
Tapa nido 34



Ref. 3.525
Tolva cuadruple alta



Ref. 3.526
Tolva cuadruple baja



Ref. 3.4589
Perfil escuadra
sup. azul



Ref. 46.1023
13 x 16 cm.
Portafichas con ficha
control

MODULO CUNITODO 12/3-T 12 Departamentos.

Todo el material metálico utilizado (alambre, chapa y tubo) es galvanizado de alta calidad, como es norma en Tecniequip. Los materiales plásticos son vírgenes y no tóxicos. Módulos polivalentes únicos en el mercado, de fácil adaptación a cualquier manejo. Apta para razas enanas y medianas. Adaptables a cualquier automatismo de alimentación y lactancia controlada (opcional). Comederos diseñados para el mejor aprovechamiento del alimento y para alimentación diferenciada (opcional), con suplemento tolva para el aumento de capacidad (opcional), eliminando pérdidas.

La empresa no se hace responsable en caso de no utilizar con los equipos, materiales originales Tecniequip. El precio del modulo es sin accesorios (en la fotografía esta con accesorios).

MEDIDAS

INTERIOR DEPARTAMENTO 335 X 900 X 310

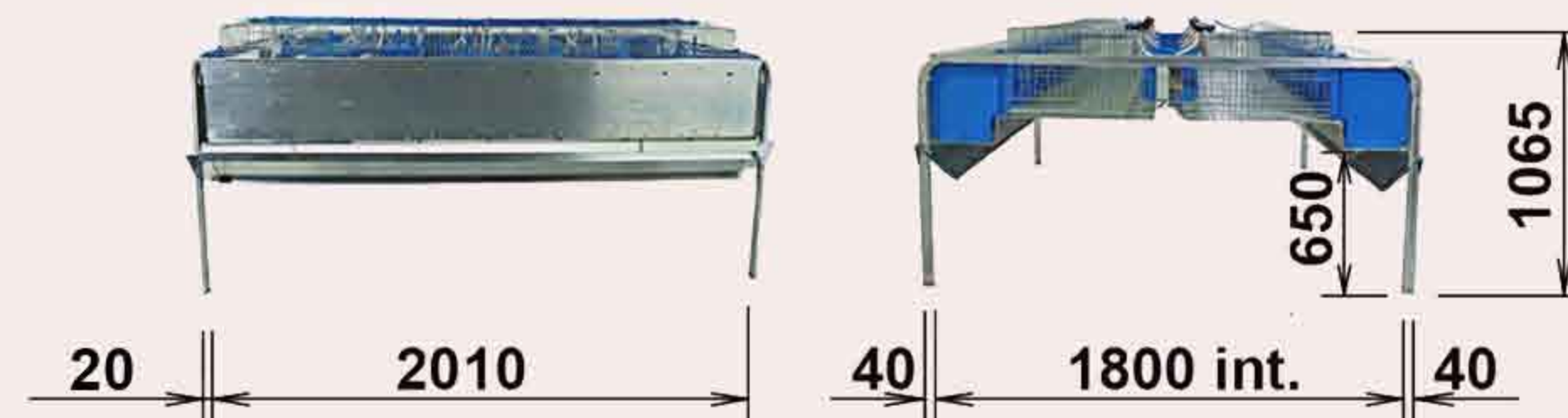



TECNIIEQUIP ANIMAL S.L.

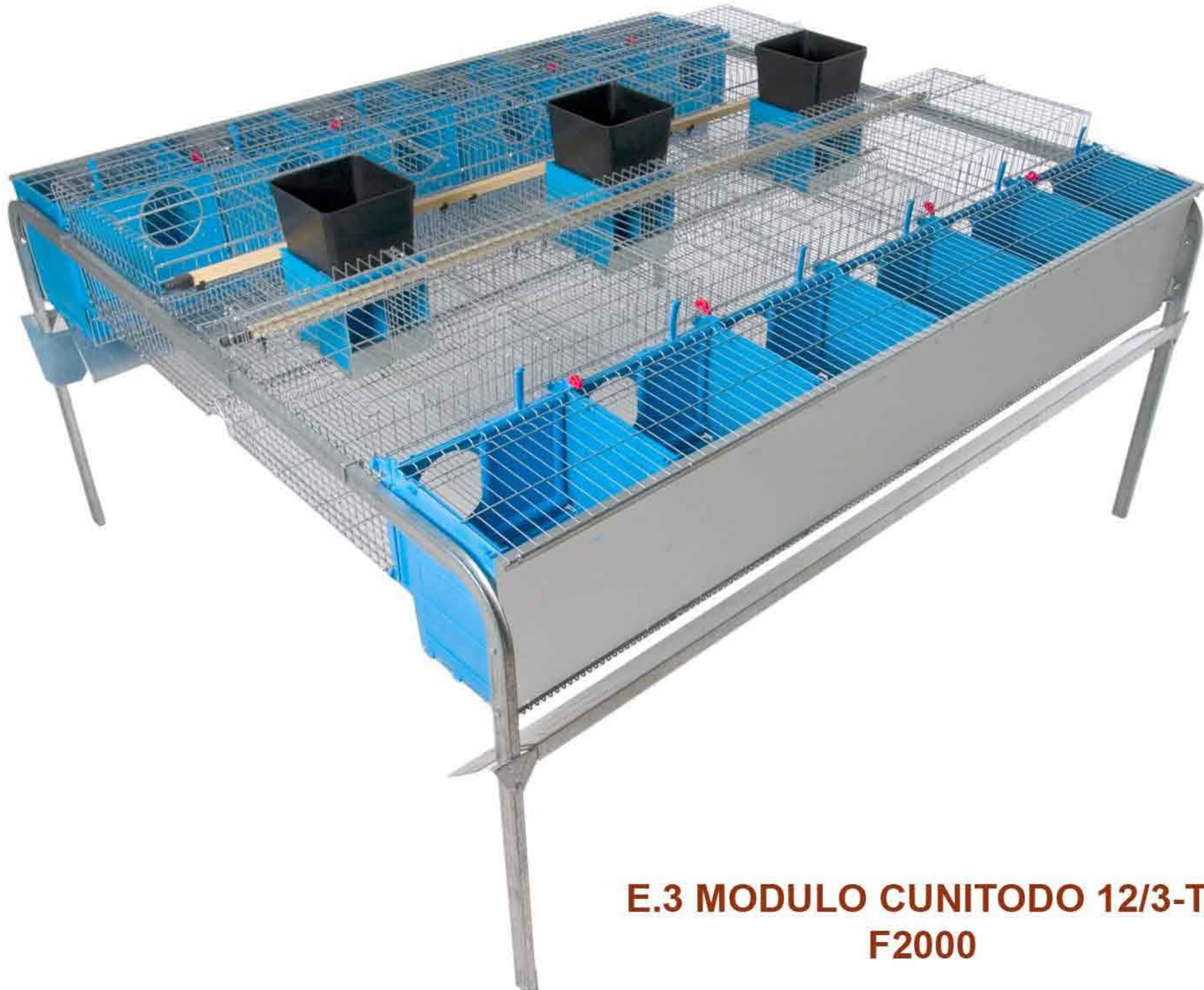

**E.3 MODULO CUNITODO 12/3-T
F2000**

ACCESORIOS



Ref. 3.4550
Comedero 4 doble



Ref. 3.4551
Supl. comedero



Ref. 3.4560
Delantero nido 34



Ref. 3.4553
Trampilla nido



Ref. 3.4554
Tramp. nido gatera



Ref. 3.4594
Protector orines



Ref. 3.4592
Caña 6 chupetes



Ref. 3.4556
Nido 34 azul



Ref. 3.4600
Caña para 6 minis



Ref. 3.4558
Curapatas



Ref. 3.5128
Deposito reg. 8 l.



Ref. 3.4583
Tapa nido 34



Ref. 3.525
Tolva cuadruple alta



Ref. 3.526
Tolva cuadruple baja

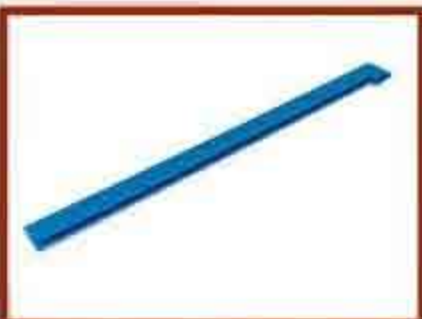

Ref. 3.4589
Perfil escuadra
sup. azul



Ref. 46. 1023
13 x 16 cm.
Portafichas con ficha
control

MODULO CUNITODO 12/3-T 12 Departamentos.

Todo el material metálico utilizado (alambre, chapa y tubo) es galvanizado de alta calidad, como es norma en Tecniequip. Los materiales plásticos son vírgenes y **no tóxicos**. Módulos polivalentes únicos en el mercado, de fácil adaptación a cualquier manejo. Apta para razas enanas y medianas. Adaptables a cualquier automatismo de alimentación y lactancia controlada (opcional). Comederos diseñados para el mejor aprovechamiento del alimento y para alimentación diferenciada (opcional), con suplemento tolva para el aumento de capacidad (opcional), eliminando pérdidas.

La empresa no se hace responsable en caso de no utilizar con los equipos, materiales originales Tecniequip. El precio del modulo es sin accesorios (en la fotografía esta con accesorios).

MEDIDAS

INTERIOR DEPARTAMENTO 335 X 900 X 310

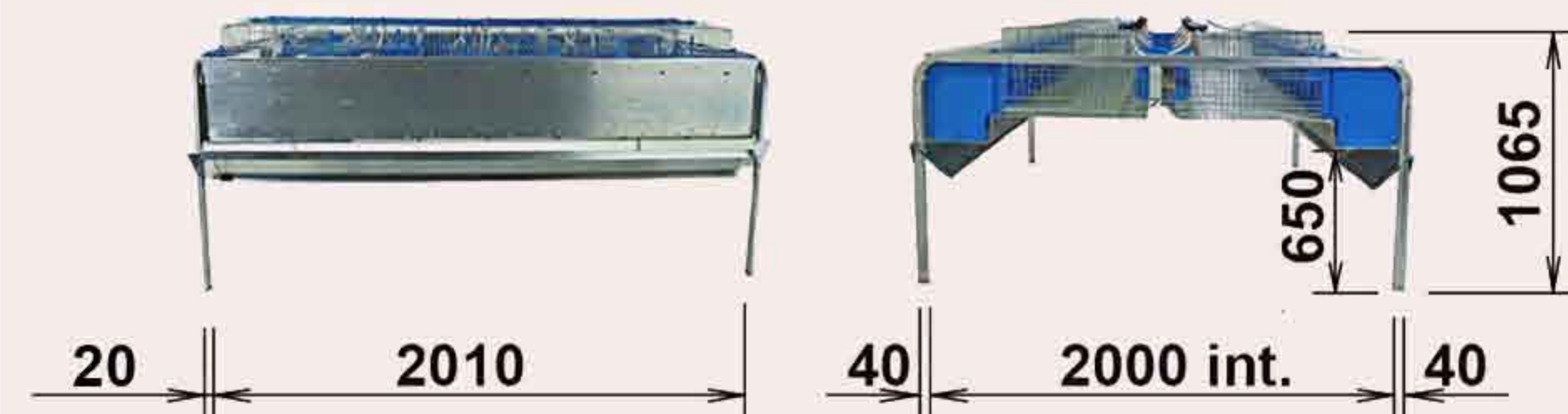



TECNIIEQUIP ANIMAL S.L.



E.3 MODULO CUNITODO 6/3-T
Ref. 45.12028

ACCESORIOS



Ref. 3.4561
Comedero 2 interior



Ref. 3.4556
Nido 34 azul



Ref. 3.4037
Bebe. mini manguera



Ref. 3.4553
Trampilla nido



Ref. 3.4554
Tramp. nido gatera



Ref. 3.4583
Tapa nido 34



Ref. 3.4558
Curapatas



Ref. 3.1054
Bebe. mini botella



Ref. 90.8738
Grapadora manual



Ref. 3.4564
Caña 4 chupetes



Ref. 3.5078
Depósito regulador
5L. con racord 10/14



Ref. 46.1023
13x16cm.
Portafichas con ficha control



Ref. 46.7024
Paleta repartidora de pienso
25x12x14 cm.



Ref. 90.7044
Muelle de cierre
7cm.

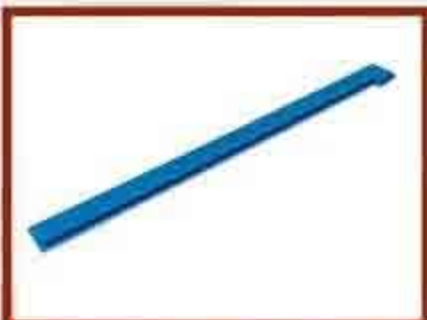

Ref. 3.4589
Perfil escuadra sup. azul.



Ref. 3.4560
Delantero nido 34



Ref. 3.5128
Deposito reg. 8 l.

JAULA CUNITODO 6/3-T

Todo el material metálico utilizado (alambre, chapa y tubo) es galvanizado de alta calidad, como es norma en Tecniequip. Los materiales plásticos son vírgenes y **no tóxicos**. Módulos polivalentes únicos en el mercado, de fácil adaptación a cualquier manejo, con alimentación y lactancia, semi-automática o automática. Con piso superior para reposición, gestación o sobre-ocupación (con nidos adaptables), mejorando el aprovechamiento del espacio. Piso inferior también polivalente (madres, engorde o machos). Comederos diseñados para el mejor aprovechamiento del alimento y para alimentación diferenciada (opcional), eliminando pérdidas.

La empresa no se hace responsable en caso de no utilizar con los equipos, materiales originales Tecniequip. El precio del modulo es sin accesorios (en la fotografía esta con accesorios).

MEDIDAS

INTERIOR DEPARTAMENTO 335 X 900 X 310

920

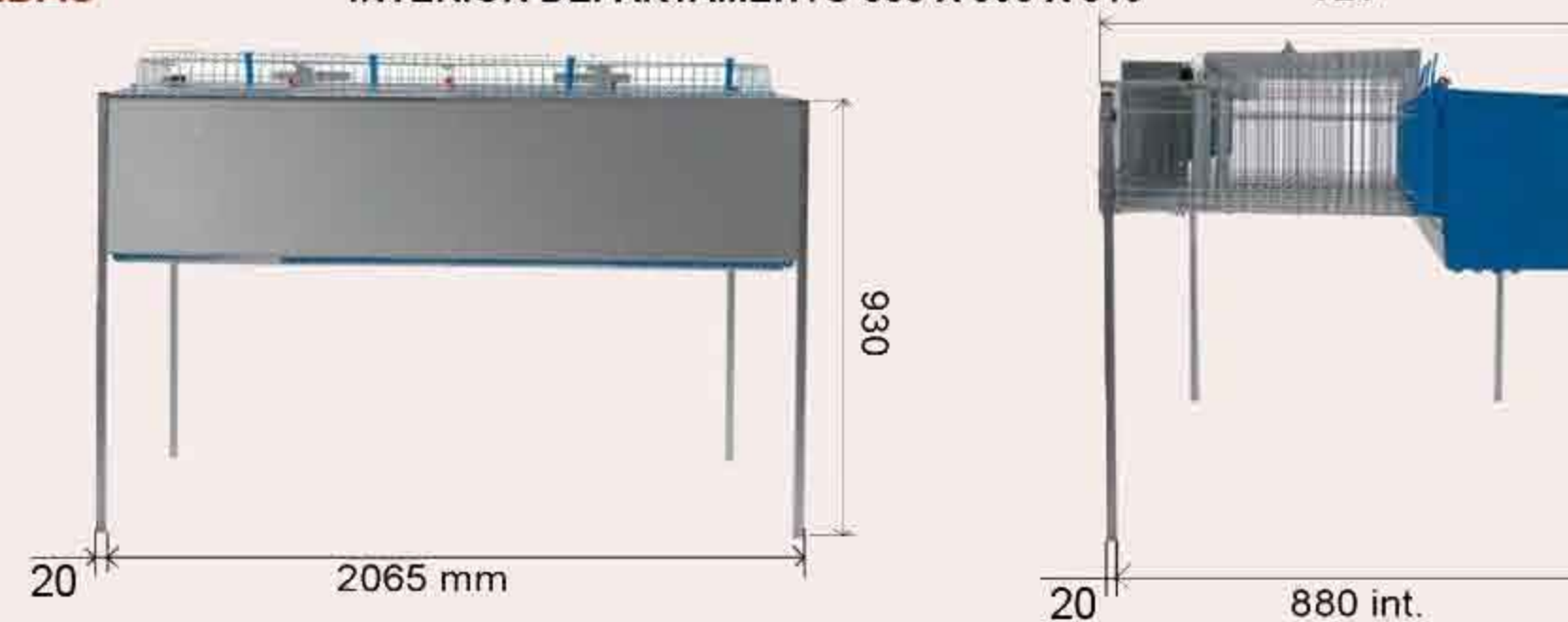



TECNI EQUIP ANIMAL S.L.



E.3 JAULA CUNITODO 4/2-T
Ref. 40.12030

ACCESORIOS



Ref. 3.4561
Comedero 2 interior



Ref. 3.4556
Nido 34 azul



Ref. 3.4037
Bebe. mini manguera



Ref. 3.4553
Trampilla nido



Ref. 3.4554
Tramp. nido gatera



Ref. 3.4583
Tapa nido 34



Ref. 3.4558
Curapatas



Ref. 3.1054
Bebe. mini botella



Ref. 90.8738
Grapadora manual



Ref. 3.4564
Caña 4 chupetes



Ref. 3.5078
Depósito regulador 5L. con racord 10/14



Ref. 46.1023
13x16cm.
Portafichas con ficha control



Ref. 46.7024
Paleta repartidora de pienso 25x12x14 cm.



Ref. 90.7044
Muelle de cierre 7cm.

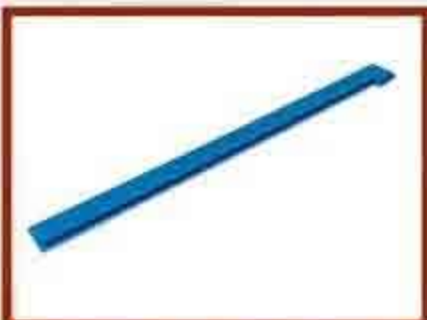

Ref. 3.4589
Perfil escuadra sup. azul.



Ref. 3.4560
Delantero nido 34



Ref. 3.5128
Deposito reg. 8 l.

JAULA CUNITODO 4/2-T

Todo el material metálico utilizado (alambre, chapa y tubo) es galvanizado de alta calidad, como es norma en Tecniequip. Los materiales plásticos son vírgenes y **no tóxicos**. Módulos polivalentes únicos en el mercado, de fácil adaptación a cualquier manejo, con alimentación y lactancia, semi-automática o automática. Con piso superior para reposición, gestación o sobre-ocupación (con nidos adaptables), mejorando el aprovechamiento del espacio. Piso inferior también polivalente (madres, engorde o machos). Comederos diseñados para el mejor aprovechamiento del alimento y para alimentación diferenciada (opcional), eliminando pérdidas.

La empresa no se hace responsable en caso de no utilizar con los equipos, materiales originales Tecniequip. El precio del modulo es sin accesorios (en la fotografía esta con accesorios).

MEDIDAS

INTERIOR DEPARTAMENTO 335 X 900 X 310

920

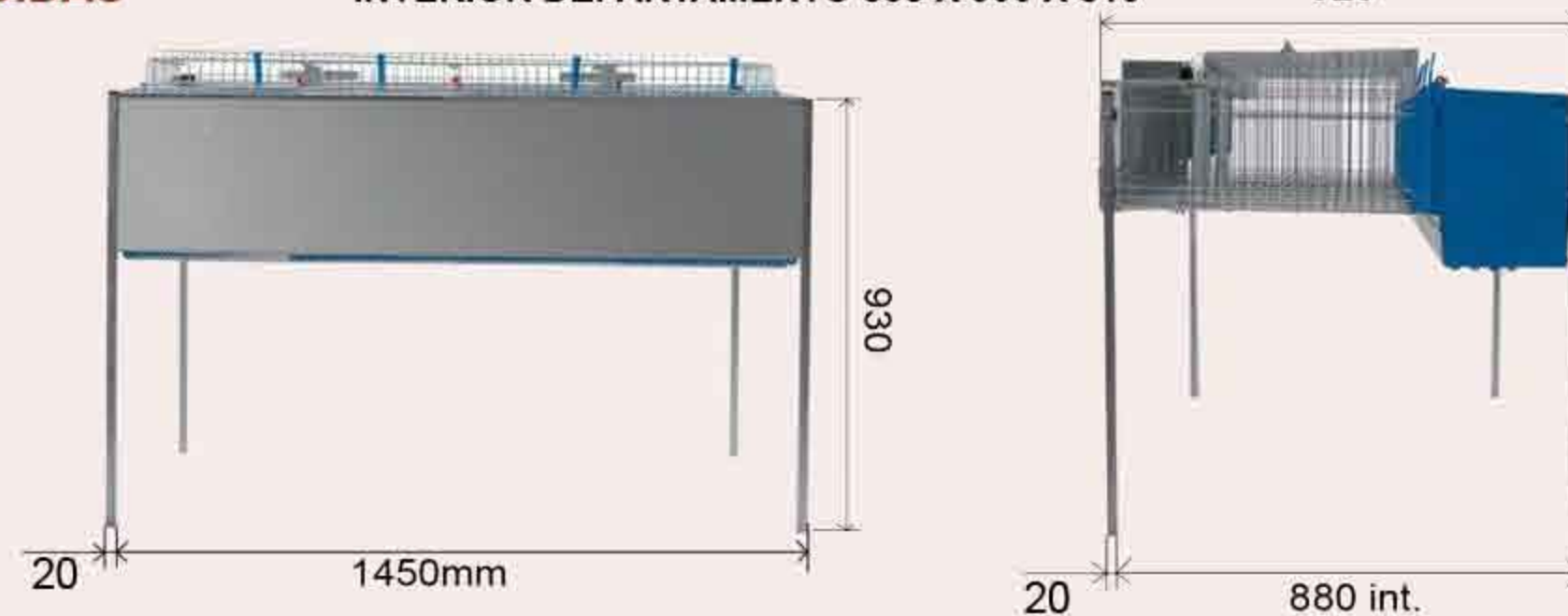



TECNIQUIP ANIMAL S.L.



E.3 JAULA CUNITODO 4/2
Ref. 40.12029

ACCESORIOS



Ref. 3.4561
Comedero 2 interior



Ref. 3.4556
Nido 34 azul



Ref. 3.4037
Bebe. mini manguera



Ref. 3.4553
Trampilla nido



Ref. 3.4554
Tramp. nido gatera



Ref. 3.4583
Tapa nido 34



Ref. 3.4558
Curapatas



Ref. 3.1054
Bebe. mini botella



Ref. 90.8738
Grapadora manual



Ref. 3.4564
Caña 4 chupetes



Ref. 3.5078
Depósito regulador
5L. con racord 10/14



Ref. 46.1023
13x16cm.
Portafichas con ficha control



Ref. 46.7024
Paleta repartidora de pienso
25x12x14 cm.



Ref. 90.7044
Muelle de cierre
7cm.

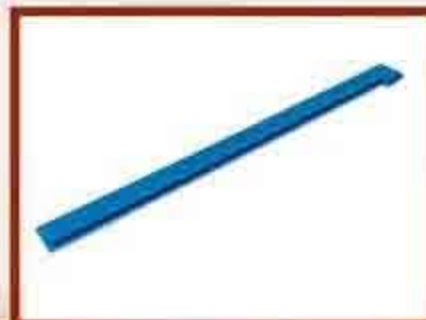

Ref. 3.4589
Perfil escuadra sup. azul



Ref. 3.4560
Delantero nido 34



Ref. 3.5128
Deposito reg. 8 l.



Ref. 3.4579
Comedero 2 aldaba



Ref. 3.4566
Caña 2 chupetes

JAULA CUNITODO 4/2

Todo el material metálico utilizado (alambre, chapa y tubo) es galvanizado de alta calidad, como es norma en Tecniequip. Los materiales plásticos son vírgenes y **no tóxicos**. Módulos polivalentes únicos en el mercado, de fácil adaptación a cualquier manejo, con alimentación y lactancia, semi-automática o automática. Con piso superior para reposición, gestación o sobre-ocupación (con nidos adaptables), mejorando el aprovechamiento del espacio. Piso inferior también polivalente (madres, engorde o machos). Comederos diseñados para el mejor aprovechamiento del alimento y para alimentación diferenciada (opcional), eliminando pérdidas.

La empresa no se hace responsable en caso de no utilizar con los equipos, materiales originales Tecniequip. El precio del modulo es sin accesorios (en la fotografía esta con accesorios).

MEDIDAS

INTERIOR DEPARTAMENTO Superior 725 x 600 x 310
Inferior 335 x 900 x 310





TECNIIEQUIP ANIMAL S.L.



E.3 JAULA MULTIUSO 8



E.3 JAULA MULTIUSO 4



E.3 JAULA MULTIUSO 2



ACCESORIOS



Ref. 3.1014
16x13x12,5
Bebedero botella
universal 2L.



Ref. 3.1015
13x13x12,5
Bebedero
automatico de boya



Ref. 3.5078
Deposito regulador 5L.
con racord 10/14



Ref. 1.502
Nido jaula
multiusos



Ref. 3.4555
39x26,5x9,5
Nido cuna 40



Ref. 3.3840
39x26x16cm.
Cuna profunda



Ref. 46.1023
13x16cm.
Portafichas con ficha
control



Ref. 3.4627
18x14x30cm.
Comedero 2
multiuso exterior
(chapa)



Ref. 3.7004
Metro manguera
10/14



Ref. 3.4021
"T" para manguera
10/14

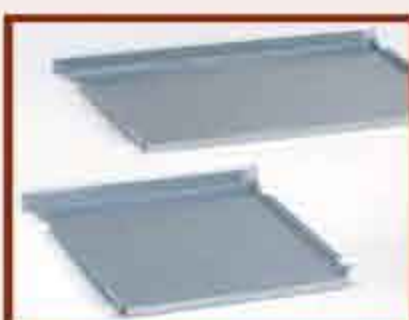

Ref. 1.503-1.504
Bandejas



Ref. 3.7009
Depósito regulador 25L.
con racord 10/14



Ref. 3.3792
Rejilla
Sandwich

E.3 JAULA MULTIUSOS

Todo el material metálico utilizado (alambre, chapa y tubo) es galvanizado de alta calidad, como es norma en Tecniequip. Los materiales plásticos son vírgenes y **no tóxicos**. Módulos polivalentes únicos en el mercado, de fácil adaptación a cualquier manejo. Nido térmico, sin humedad y a temperatura óptima. Suelo de jaula tipo RELAX de plástico que evita el mal de patas. Puede utilizarse en alimentación mixta, disponen de rastrillo para forraje y comedero para pienso. Bebederos semiautomáticos de 2 L. en plástico reforzado. Presentación en Kit, fácil de transportar y almacenar.

La empresa no se hace responsable en caso de no utilizar con los equipos, materiales originales Tecniequip. El precio del módulo es sin accesorios (en la fotografía esta con accesorios).

MEDIDAS

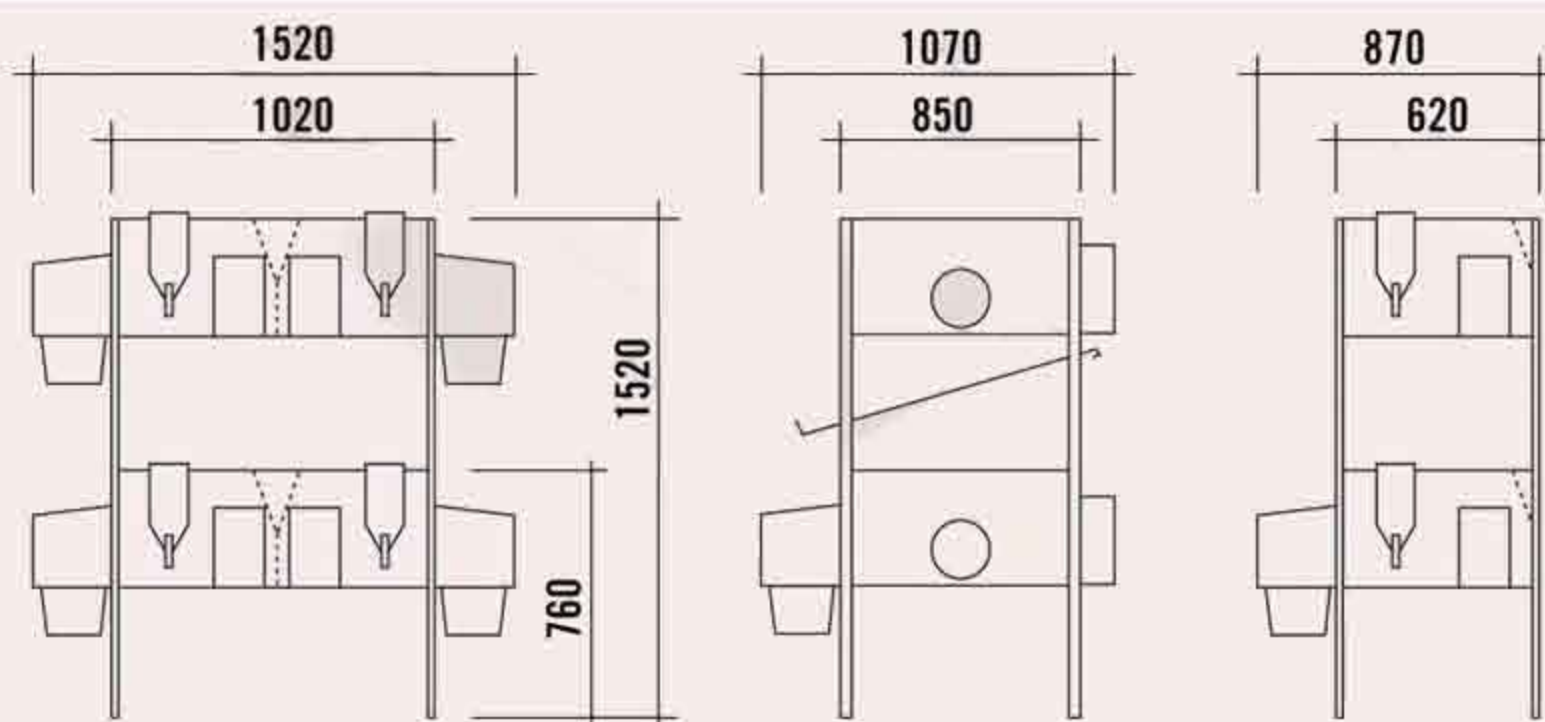



TECNIQUIP ANIMAL S.L.

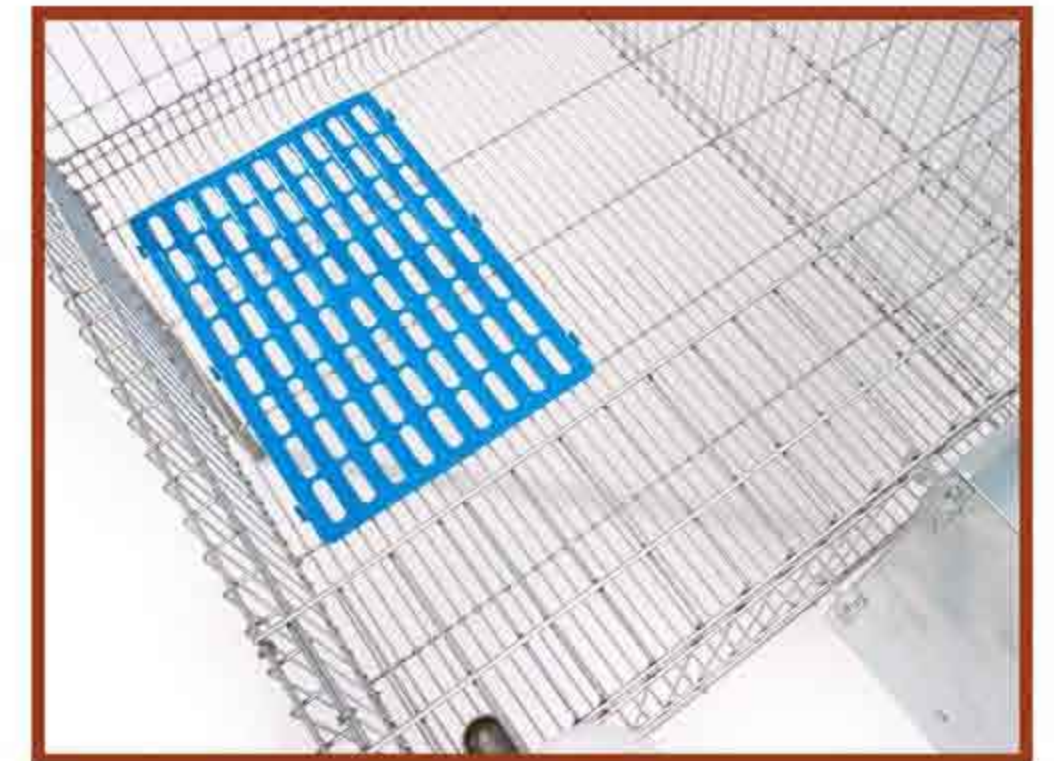

**MODULO FAMILIAR/ENGORDE
MADRES.4
Ref.45.12088**

ACCESORIOS



Ref. 3.4638
Comedero 2 Exterior
Familiar
18x14x30 cm.
(Chapa)



Ref. 3.4639
Aldaba para
comedero
Fam. chapa



Ref. 3.4558
Curapatas relax



Ref. 3.3173
Caña 2m. 4 codos
con chupete.



Ref. 46.1023
Portafichas con
ficha control
13x16



Ref. 40.301
Lateral chapa



Ref. 3.4038
Escuadra fijación
caña y mini.



Ref. 3.4037
Bebedero mini
manguera



Ref. 90.8738
Grapadora
manual



Ref. 3.1054
Bebe. Mini botella
2L.



Ref. 3.5078
Depósito regulador
5L. con racord 10/14



Ref. 3.7009
Depósito regulador
25L. con racord 10/14



Ref. 46.7024
Paleta repartidora
de pienso
25x12x14 cm.



Ref. 3.806
Nido universal
40x27x33 cm.



Ref. 3.740
Caña 2m. 4 mini
manguera
engorde

FAMILIAR ENGORDE/MADRES . 4

Todo el material metálico utilizado (alambre, chapa y tubo) es galvanizado de alta calidad, como es norma en Tecniequip. Los materiales plásticos son vírgenes y **no tóxicos**. Módulos polivalentes únicos en el mercado, de fácil adaptación a cualquier manejo, con alimentación y lactancia, semi-automática o automática. Con piso superior para reposición, gestación o sobre-ocupación (con nidos adaptables), mejorando el aprovechamiento del espacio. Piso inferior también polivalente (madres, engorde o machos). Comederos diseñados para el mejor aprovechamiento del alimento y para alimentación diferenciada (opcional), eliminando pérdidas.

La empresa no se hace responsable en caso de no utilizar con los equipos, materiales originales Tecniequip. El precio del modulo es sin accesorios (en la fotografía esta con accesorios).

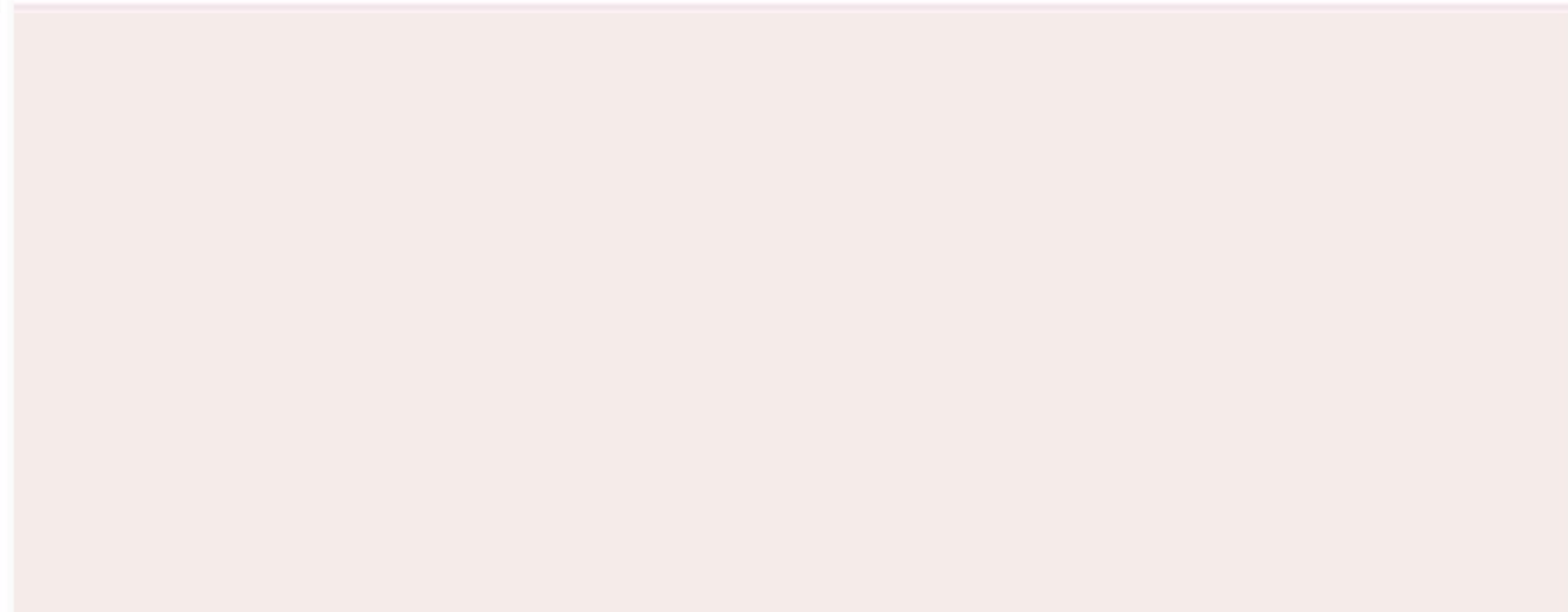
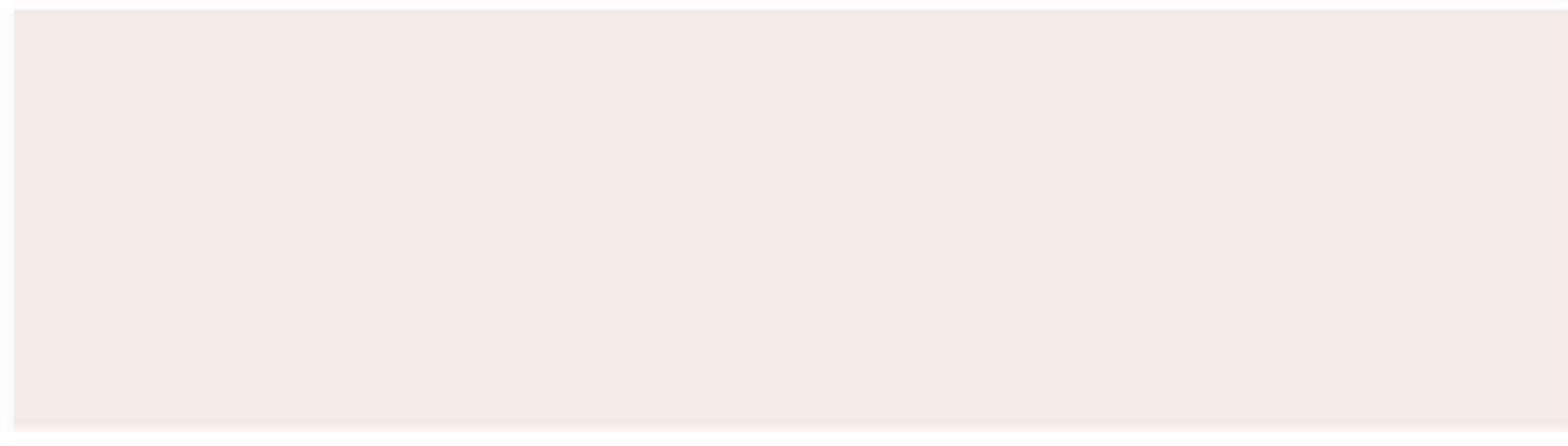
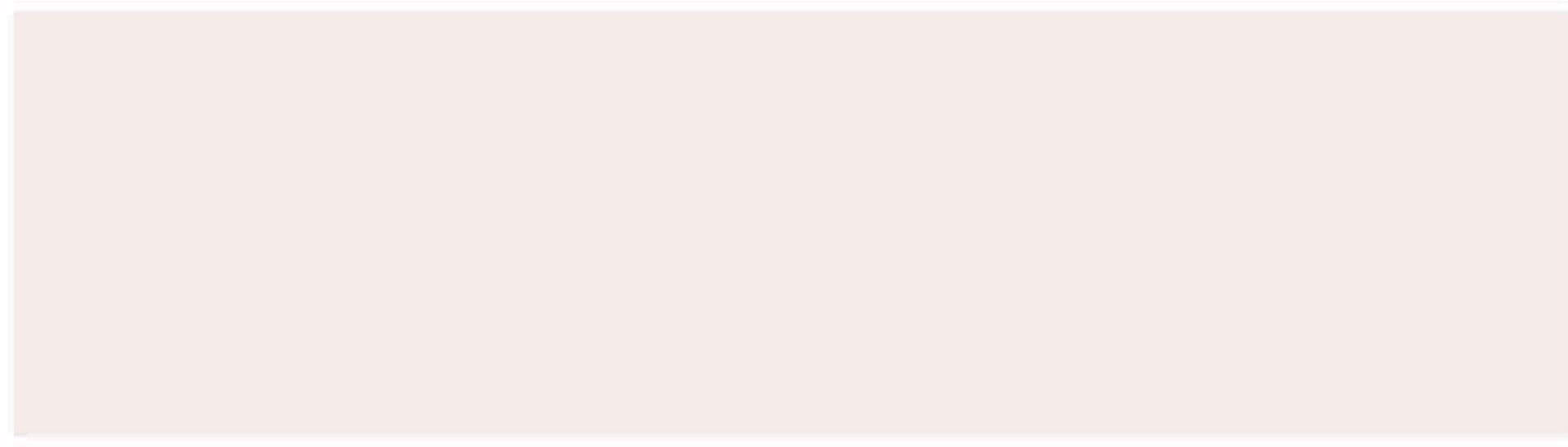
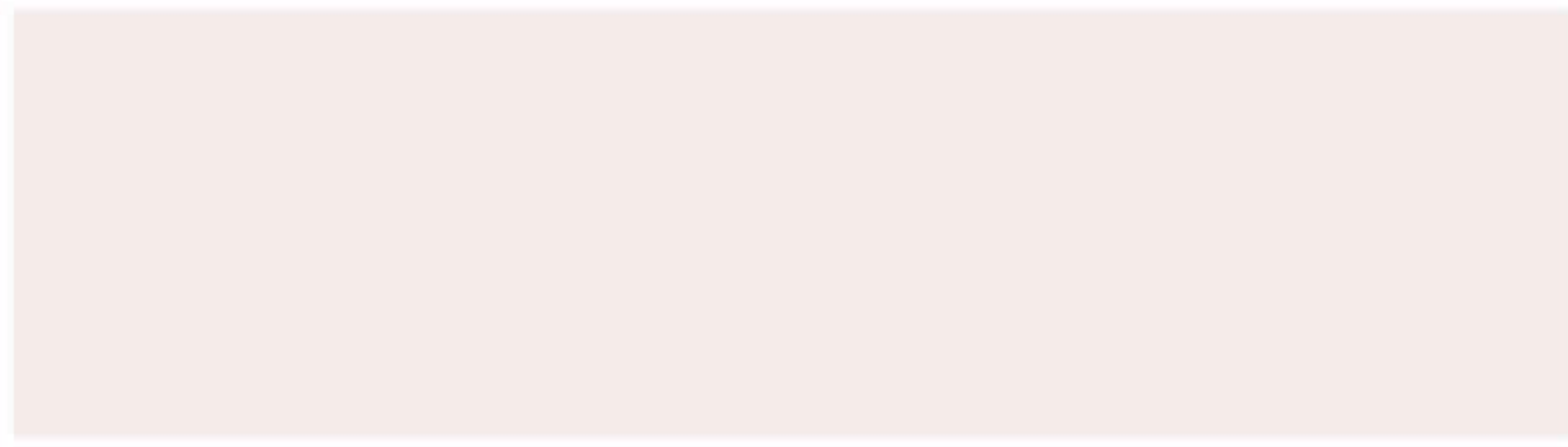

MEDIDAS

INTERIOR DEPARTAMENTO 650 X 600 X 310





TECNIEQUIP ANIMAL S.L.

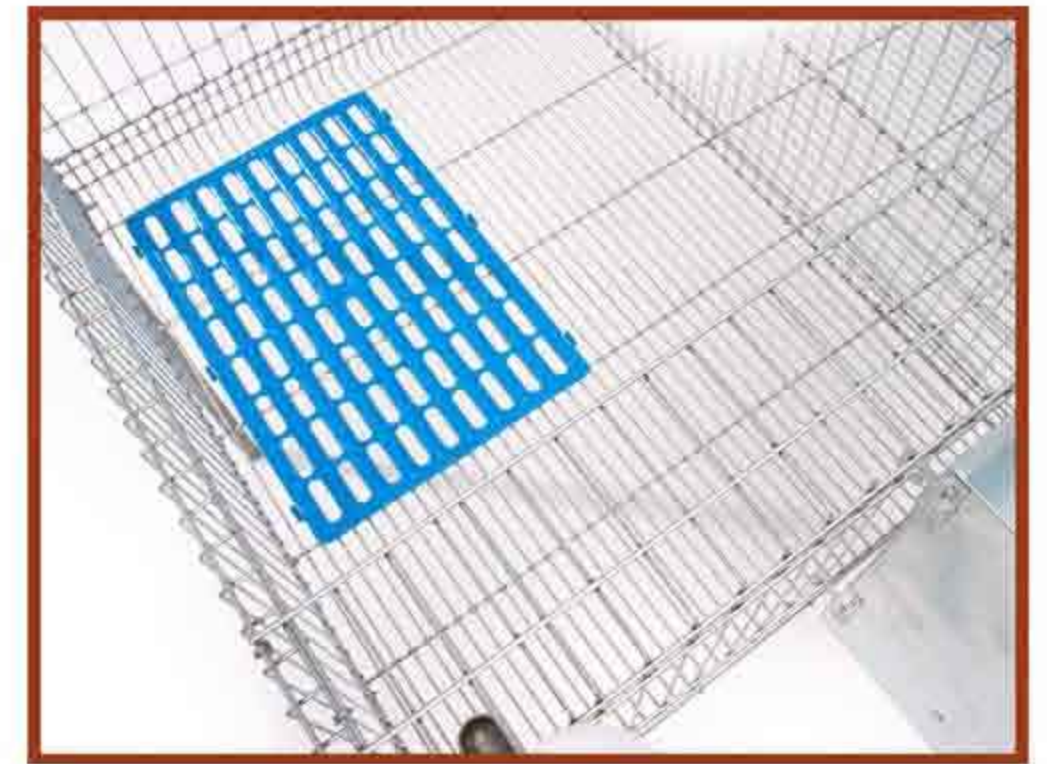

MODULO FAMILIAR MADRES .4
Ref. 45.12090

ACCESORIOS



Ref. 3.4638
Comedero 2 exterior
Familiar
18x14x30 cm.
(chapa)



Ref. 3.799
Reposapatas
(plástico / chapa)



Ref. 3.4639
Aldaba para
comedero
Fam. chapa



Ref. 3.3792
Rejilla sandwich



Ref. 46.1023
Portafichas con
ficha control
13x16



Ref. 3.3840
Cuna profunda



Ref. 3.4555
Nido cuna 40



Ref. 3.4037
Bebedero mini
manguera



Ref. 90.8738
Grapadora
manual



Ref. 3.1054
Bebe. Mini botella
2L.



Ref. 3.5078
Depósito regulador
5L. con racord 10/14



Ref. 3.7009
Depósito regulador
25L. con racord 10/14



Ref. 46.7024
Paleta repartidora
de pienso
25x12x14 cm.



Ref. 3.4038
Escuadra fijación
caña y mini.



Ref. 3.3173
Caña 2m. 4 codos
con chupete.



Ref. 40.301
Lateral chapa



Ref. 3.739
Caña 2m. 4 mini
manguera
madres.

MODULO FAMILIAR MADRES . 4

Todo el material metálico utilizado (alambre, chapa y tubo) es galvanizado de alta calidad, como es norma en Tecniequip. Los materiales plásticos son vírgenes y **no tóxicos**. Módulos polivalentes únicos en el mercado, de fácil adaptación a cualquier manejo, con alimentación y lactancia, semi-automática o automática. Con piso superior para reposición, gestación o sobre-ocupación (con nidos adaptables), mejorando el aprovechamiento del espacio. Piso inferior también polivalente (madres, engorde o machos). Comederos diseñados para el mejor aprovechamiento del alimento y para alimentación diferenciada (opcional), eliminando pérdidas.

La empresa no se hace responsable en caso de no utilizar con los equipos, materiales originales Tecniequip. El precio del modulo es sin accesorios (en la fotografía esta con accesorios).

MEDIDAS

INTERIOR DEPARTAMENTO 650 X 600 X 310

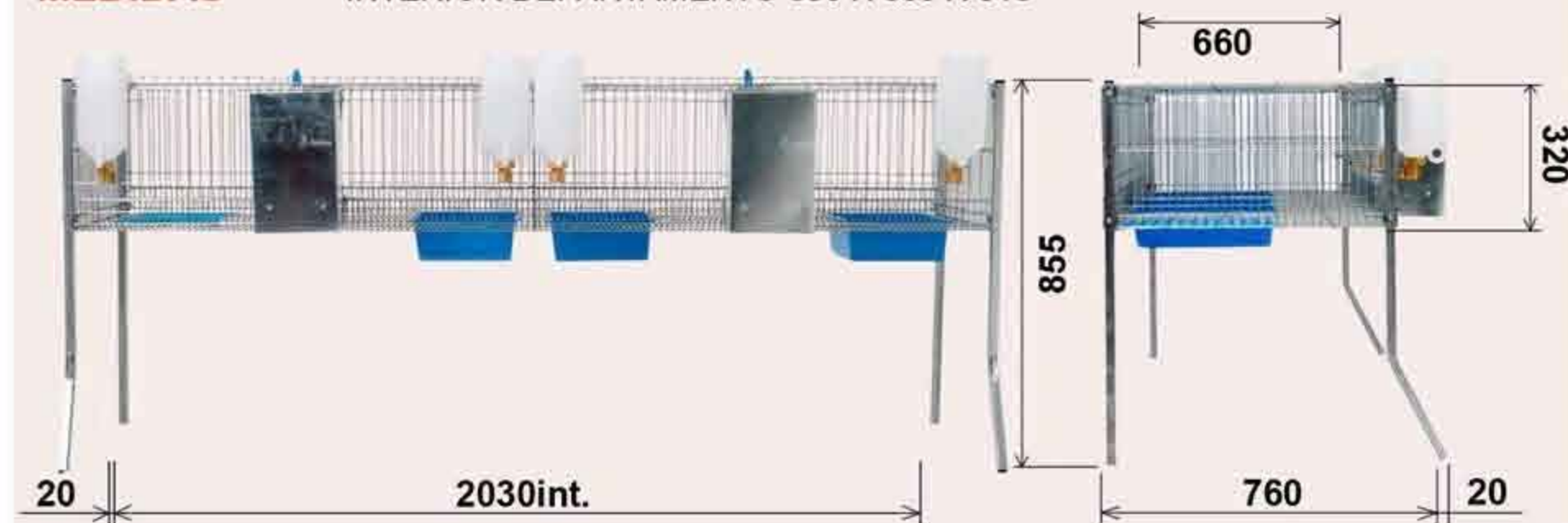



CUNICULTURA, ACCESORIOS GAMA E.3



Ref. 3.4550 18x22,5x21,5 cm.
Comedero 4 doble (plástico/chapa)



Ref. 3.4551 29x24x15 cm.
Suplemento comedero 4 doble
(plástico)



Ref. 3.4552 39,5x24 cm.
Delantero nido 40 (plástico)



Ref. 3.4560 33,5x24 cm.
Delantero nido 34 (plástico)



Ref. 3.4553 16,5x22 cm.
Trampilla nido (plástico)



Ref. 3.4554 16,5x22 cm.
Trampilla nido gatera (plástico)



Ref. 3.3840 39x26x16 cm.
Cuna profunda (plástico)



Ref. 3.4555 39x26,5x9,5 cm.
Nido cuna 40 (plástico)



CUNICULTURA, ACCESORIOS GAMA E.3



Ref. 3.4557 39x26x11 cm.
Nido 40 (plástico)



Ref. 3.4556 33x26x11 cm.
Nido 34 (plástico)



Ref. 3.4584 39x24 cm.
Tapa nido 40 (plástico transparente)



Ref. 3.4583 33x24 cm.
Tapa nido 34 (plástico transparente)

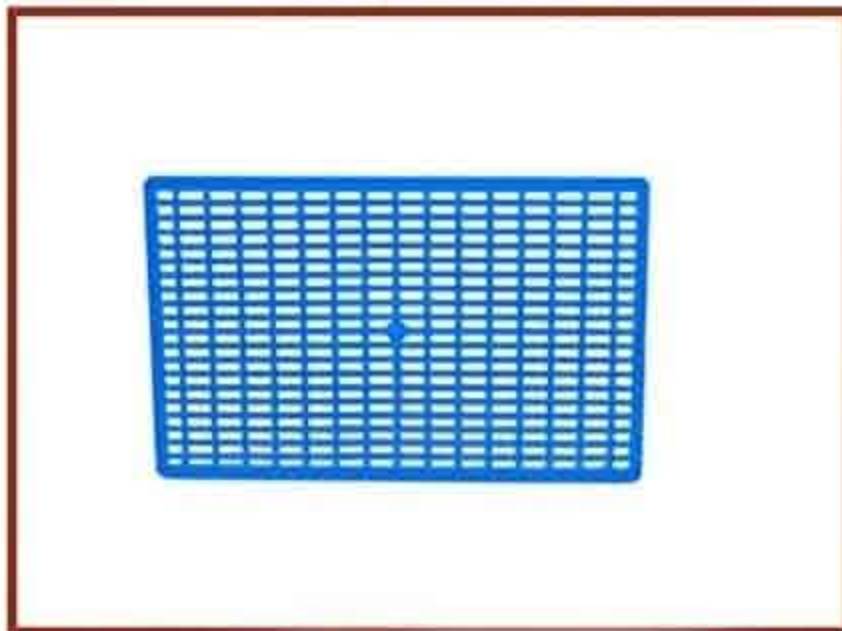

Ref. 3.3792 33,5x21,5 cm.
Rejilla sandwich (plástico)



Ref. 3.4558 37,5x25,5 cm.
Curapatas relax (plástico)



Ref. 40.311 38,5x25,5 cm.
Curapatas relax Ecus (plástico)



Ref. 3.799 38,5x26 cm.
Reposapatas (plástico/chapa)



CUNICULTURA, ACCESORIOS GAMA E.3



Ref. 3.4638 18x14x30 cm.
Comedero 2 exterior familiar (chapa)



Ref. 3.4903 27x14x27 cm.
Tolva M-3 (chapa)



Ref. 3.526 18x22x21,5 cm.
Tolva cuadruple baja (chapa)



Ref. 3.525 18x22x38 cm.
Tolva cuadruple alta (chapa)



Ref. 3.4561 18x14x30 cm.
Comedero 2 interior (chapa)



Ref. 3.4579 18x14x30 cm.
Comedero 2 interior aldaba (chapa)



Ref. 3.4627 18x14x30 cm.
Comedero 2 multiuso exterior (chapa)



Ref. 3.4902 18x14x30 cm.
Tolva M-2 Ecus (chapa)



CUNICULTURA, ACCESORIOS GAMA E.3



Ref. 3.33831
Alargadera caña 1,5 cm. para bebedero chupete



Ref. 3.34017
Codo caña para bebedero chupete



Ref. 3.34046
Alargadera caña 3cm para bebedero chupete



Ref. 3.34156
Alargadera caña 6cm para bebedero chupete



Ref. 3.37112
Junta caña bebedero chupete



Ref. 3.34142
Codo conexión manguera caña



Ref. 3.3180
Soporte clip conexión manguera bebedero chupete



Ref. 3.4047
Bebedero chupete inox.



CUNICULTURA, ACCESORIOS GAMA E.3



Ref. 3.4120 22x22cm.
Empalme flexible caña cuadrada

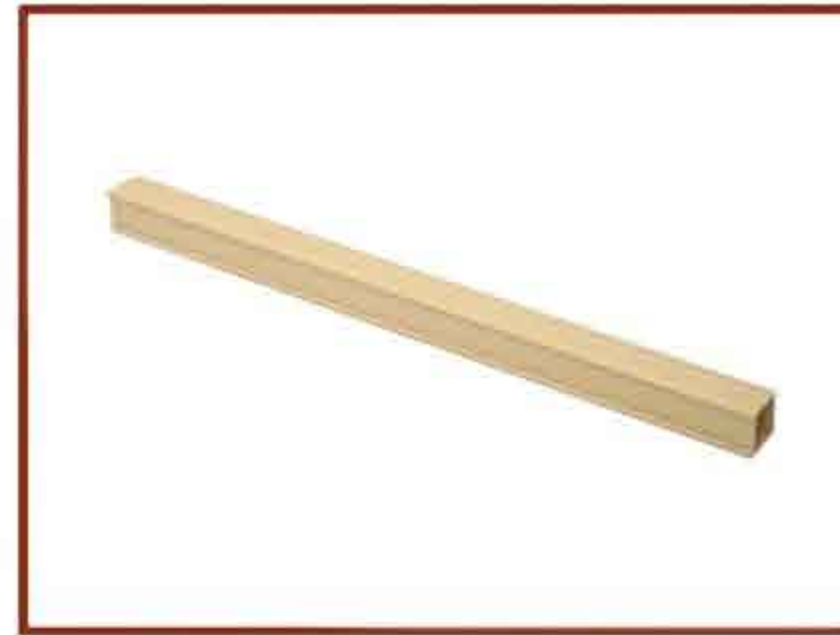

Ref. 3.4628
Caña PVC, metro lineal para
alargadera bebedero chupete



Ref. 3.4045
Terminal de caña PVC 18



Ref. 3.4630 22x22x2,5cm.
Caña PVC, metro lineal para
bebedero chupete



Ref. 3.4629 22x22,18cm.
Terminal caña con junta



Ref. 3.5128
Depósito regulador 8L. con soporte



Ref. 3.5078
Depósito regulador 5L. con racord
10/14



Ref. 3.7009
Depósito regulador 25 L. con racord
10/14



CUNICULTURA, ACCESORIOS GAMA E.3



Ref. 3.4661
Kit final de línea para tubo cuadrado



Ref. 3.1014 16x13x32,5 cm.
Bebedero botella universal 2L.



Ref. 3.1015 13x13x12,5cm.
Bebedero automático de boya



Ref. 3.1054 16x10x28cm.
Bebedero botella mini 2L.



Ref. 3.4037 5,5x10x6cm.
Bebedero mini manguera



Ref. 3.8763 5,5x10x5 cm.
Bebedero mini caña



Ref. 90.7058 9cm.
Muelle cierre fijación caña



Ref. 3.4600 200cm.
Caña 6 minis manguera con protector



CUNICULTURA, ACCESORIOS GAMA E.3



Ref. 20.5050 3,5x16cm.
Boya de nivel 10



Ref. 20.3300 13x16cm.
Boya de nivel flotador R23



Ref. 3.9166 11x31cm.
Boya de nivel depósito 8L.



Ref. 3.7116
Filtro depósito 18



Ref. 3.7004
Metro manguera 10/14



Ref. 3.7006
Metro manguera 18/21



Ref. 3.4021
"T" para manguera 10/14



Ref. 3.4048
"T" para manguera 18/21



CUNICULTURA, ACCESORIOS GAMA E.3



Ref. 3.4119
Empalme manguera 10/14



Ref. 3.4053
Adaptador de manguera 18/21 a 10/14



Ref. 3.5098
Pitorro de plástico con tuerca y arandelas para deposito 10/14



Ref. 3.8753
Tapón P/terminal caña PVC 19



Ref. 3.4039
Filtro conexión a tubo. Diametro 10



Ref. 3.4124
Alargadera 9 cm. a rosca



Ref. 3.4063
Codo a rosca



Ref. 3.4062
Alargadera 6cm. a rosca



CUNICULTURA, ACCESORIOS GAMA E.3

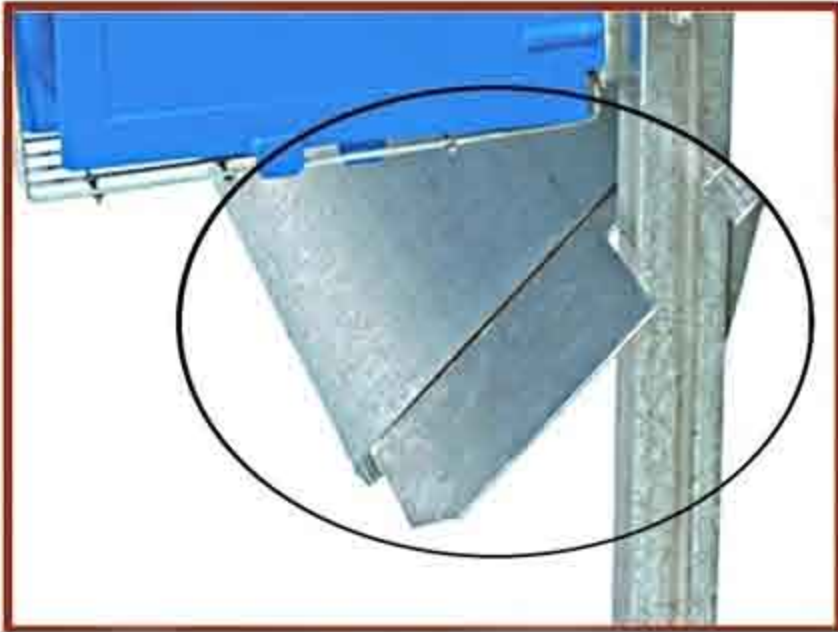

Ref. 40.3178
Soporte protector orines



Ref. 3.4559 240cm.
Protector orines con soporte



Ref. 3.4594 200cm.
Protector orines con soporte

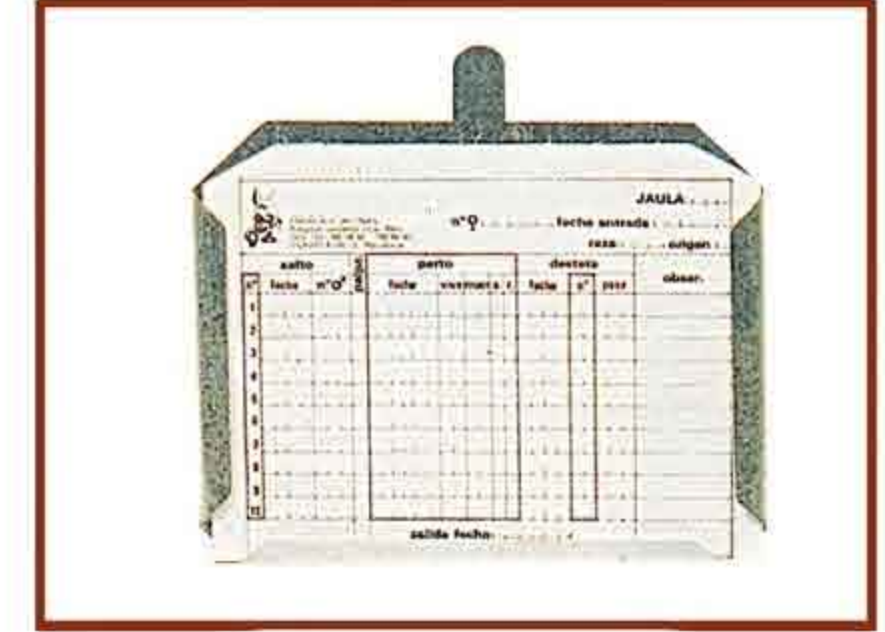

Ref. 46.1070 21x14cm.
Portafichas con ficha control

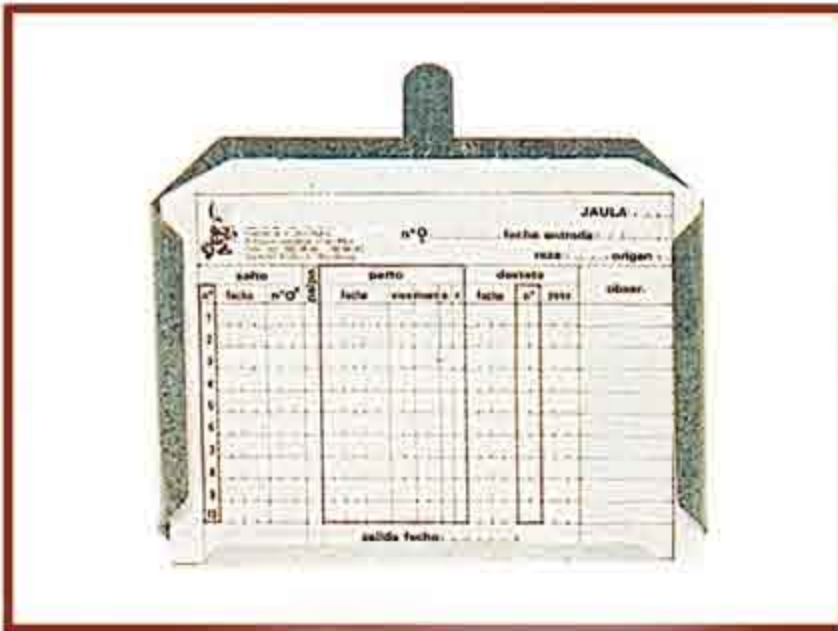

Ref. 46.1023 13x16cm.
Portafichas con ficha control



Ref. 40.660
Separador para comedero 4 doble
plástico alimentación polivalente



Ref. 40.659
Separador para comedero 4 doble
plástico alimentación diferenciada



Ref. 46.6015
Sonda final línea capacitiva



CUNICULTURA, ACCESORIOS GAMA E.3



Ref. 3.4606
Sensor con soporte



Ref. 3.4602
Sensor sin soporte



Ref. 40.91472 38,5x162cm.
Tolva alimentación automática de 150kg



Ref. 3.4589
Protector escuadra superior azul
Gama E.3

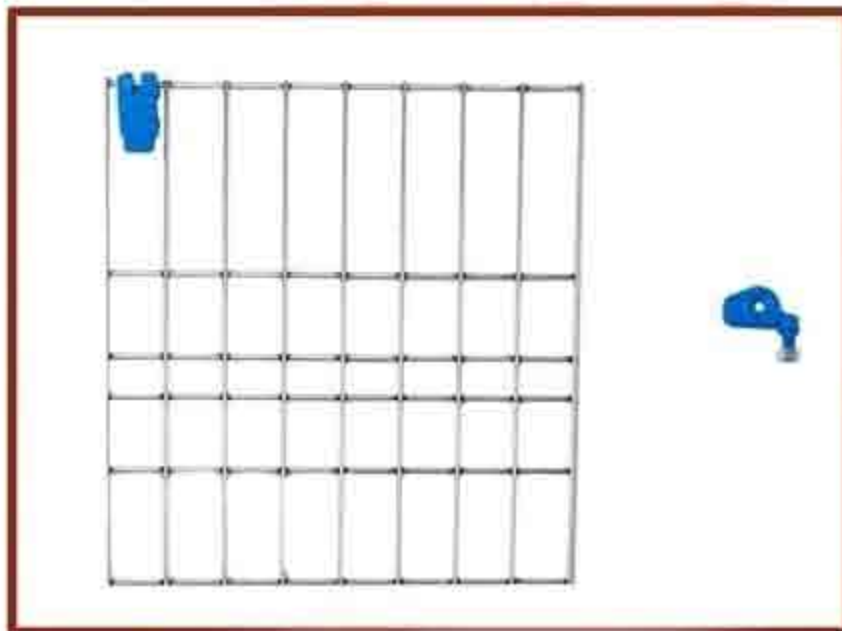

Ref. 3.3309
Puerta nido cuna 40 sobreocupación



Ref. 3.3308
Soporte nido cuna 40 sobreocupación



Ref. 90.7044
Muelle de cierre 7cm.



Ref. 90.7051
Muelle de cierre 10cm.



CUNICULTURA, ACCESORIOS GAMA E.3



Ref. 40.12024 122x110x68cm.
Carro alimentación 300kg.



Ref. 46.1080 50x70x158cm.
Carro transporte conejos doble
20 dptos.



Ref. 46.7024 25x12x14cm.
Paleta repartidora de pienso



Ref. 1.1052 65x49cm.
Suelo relax multiuso (plástico)



Ref. 3.4582
Kit descanso (alambre)



Ref. 3.4662
Bascula 10 Kg.



Ref. 3.806 40x27x33cm.
Nido universal



Ref. 46.1040 57x95x27,5cm.
Jaula transporte plegable (plástico)



CUNICULTURA, ACCESORIOS GAMA E.3



Ref. 90.9960
Compresor de aire



Ref. 90.9954
Enchufe racord

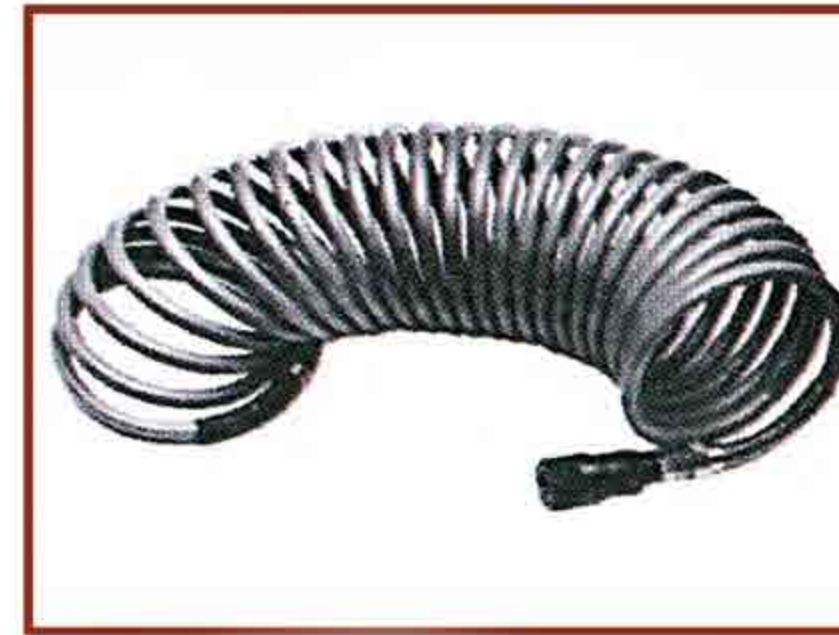

90.9951 4m.
Manguera flexo grapadora neumática



Ref. 90.9950
Grapadora neumática



Ref. 90.7020
Grapadora manual con cargador



Ref. 90.7025
Grapadora manual



Ref. 90.8738
Grapadora manual (duración limitada)



Ref. 90.2741 18x10mm.
Caja 1.000 grapas de alambre

CUNICULTURA, ACCESORIOS GAMA E.3

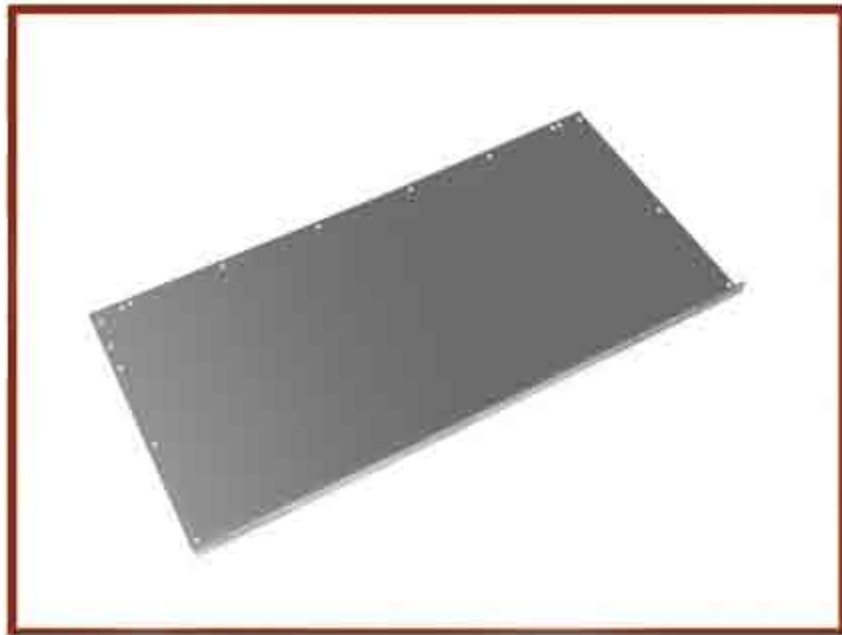

Ref. 40.301
Lateral chapa jaula familiar



Ref. 3.739
Caña 2m. 4 mini manguera madres jaula familiar



Ref. 3.740
Caña 2m. 4 mini manguera engorde jaula familiar



Ref. 3.3173
Caña 2m. 4 codos chupete jaula familiar



Ref. 3.4639
Aldaba para comedero 2 ext. familiar (chapa)



Ref. 3.4038
Escuadra fijación caña y mini



Ref. 46.91272
Boca silo Ø 75 alimentación transversal



Ref. 46.91273
Unidad inicio telescópica con tubo de 1m. alimentación transversal



CUNICULTURA, ACCESORIOS GAMA E.3



Ref. 46.91274
Bajante telescópico 1 m. Alimentación transversal

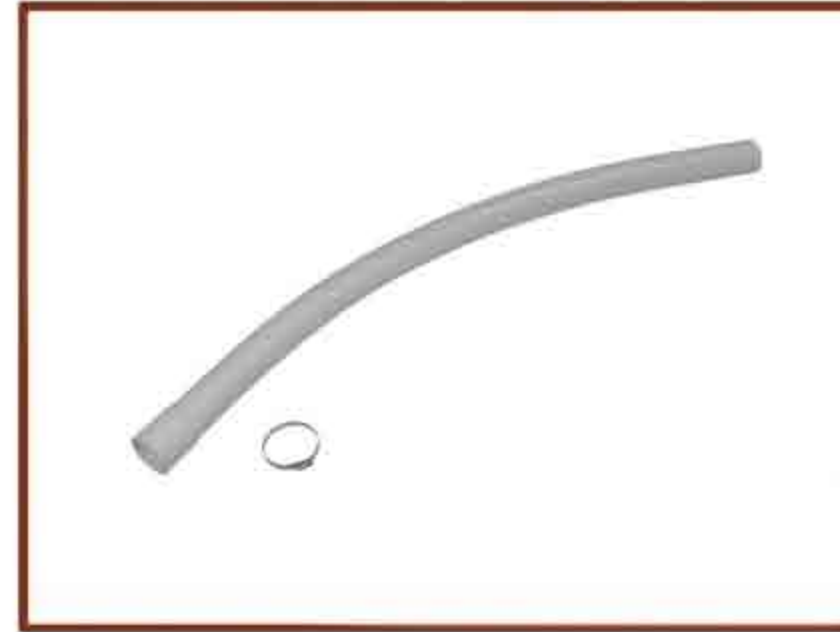

Ref. 46.91275
Tubo curvo 45° 1,5m. Ø 75.
Alimentación Transversal



Ref. 46.91276
Tubo 3m. Ø 75. Alimentación transversal



Ref. 46.91277
Metro de espiral para tubo Ø 75 1 m.
Alimentación transversal



TECNIEQUIP ANIMAL S.L.



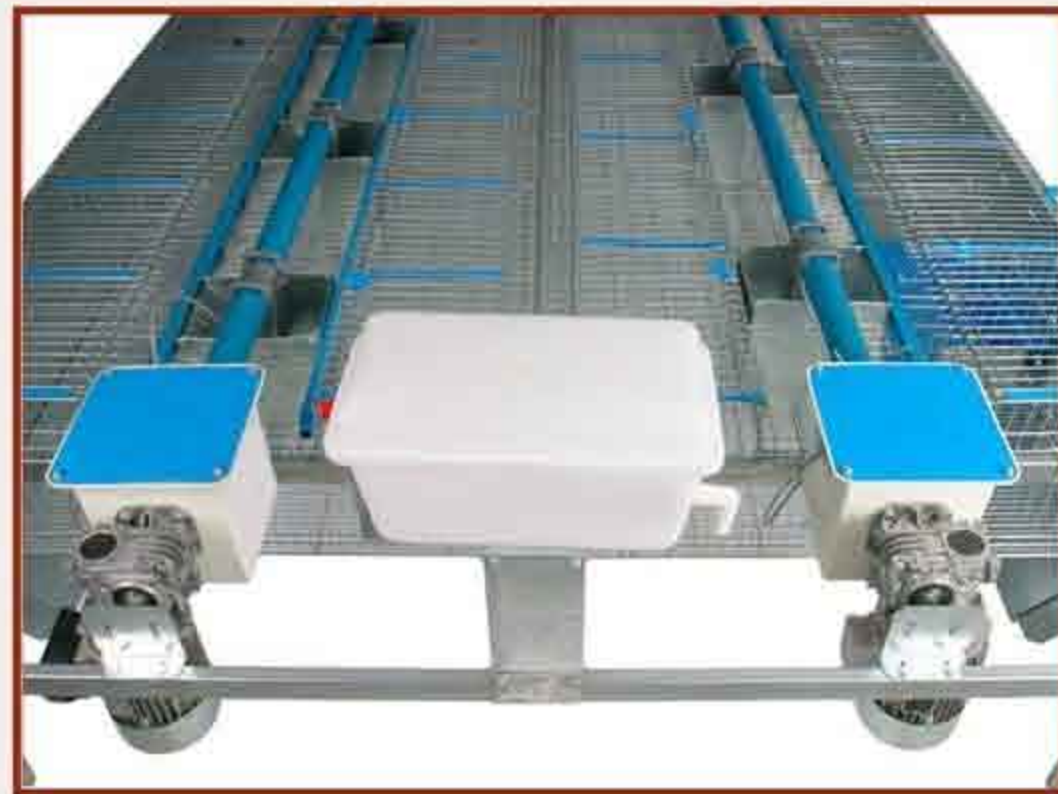

INICIO ALIMENTACION DOBLE CENTRAL E.3 2400 Ref.40.12003



INICIO ALIMENTACION TRIPLE CENTRAL E.3 2400 Ref.40.12007



TECNIQUIP ANIMAL S.L.

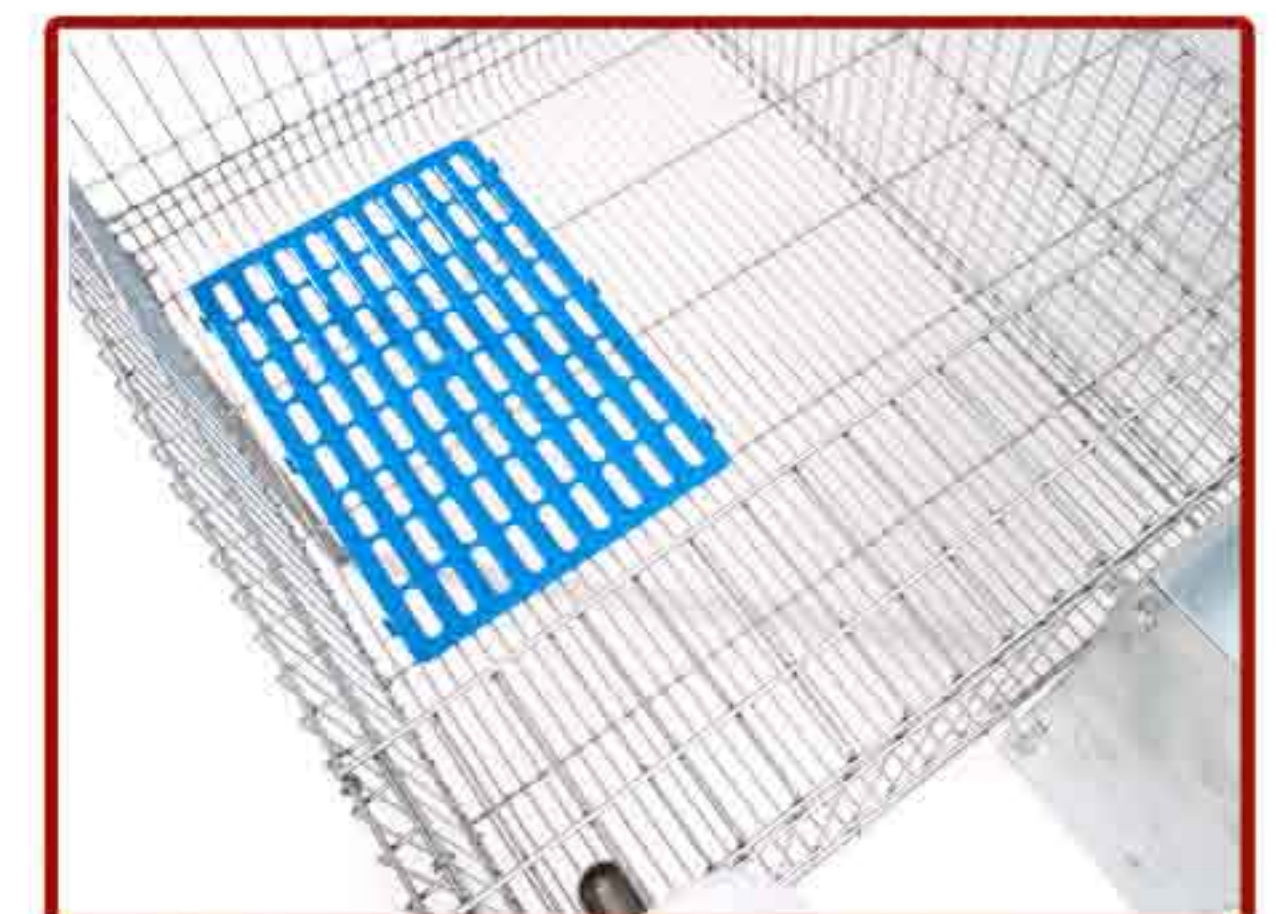

JAULA FAMILIAR MADRES 4 / ENGORDE 4
Ref. 45.12091

ACCESORIOS



Ref. 3.4638
Comedero 2 exterior
Familiar
18x14x30 cm.
(Chapa)



Ref. 3.799
Reposapatas
(plástico / chapa)



Ref. 3.4639
Aldaba para
comedero
Fam. chapa

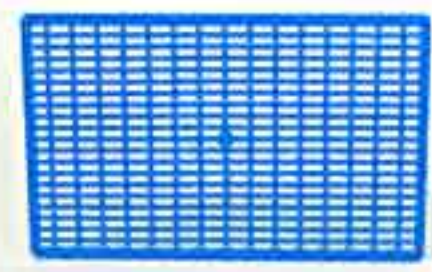

Ref. 3.3792
Rejilla sandwich



Ref. 46.1023
Portafichas con
ficha control
13x16



Ref. 3.3840
Cuna profunda



Ref. 3.4555
Nido cuna 40



Ref. 40.301
Lateral chapa



Ref. 90.8738
Grapadora
manual



Ref. 3.1054
Bebe. Mini botella
2L.



Ref. 3.5078
Depósito regulador
5L. con racord 10/14



Ref. 3.7009
Depósito regulador
25L. con racord 10/14



Ref. 46.7024
Paleta repartidora
de pienso
25x12x14 cm.



Ref. 3.4038
Escuadra fijación
caña y mini



Ref. 3.3173
Caña 2m. 4 codos
con chupete



Ref. 3.739
Caña 2m. 4 mini
manguera
madres.



Ref. 3.740
Caña 2m. 4 mini
manguera
engorde.

JAULA FAMILIAR MADRES 4 / ENGORDE 4

Todo el material metálico utilizado (alambre, chapa y tubo) es galvanizado de alta calidad, como es norma en Tecniequip. Los materiales plásticos son vírgenes y **no tóxicos**. Módulos polivalentes únicos en el mercado, de fácil adaptación a cualquier manejo, con alimentación y lactancia, semi-automática o automática. Con piso superior para reposición, gestación o sobre-ocupación (con nidos adaptables), mejorando el aprovechamiento del espacio. Piso inferior también polivalente (madres, engorde o machos). Comederos diseñados para el mejor aprovechamiento del alimento y para alimentación diferenciada (opcional), eliminando pérdidas.

La empresa no se hace responsable en caso de no utilizar con los equipos, materiales originales Tecniequip. El precio del modulo es sin accesorios (en la fotografía esta con accesorios).

MEDIDAS

INTERIOR DEPARTAMENTO 650 X 600 X 310

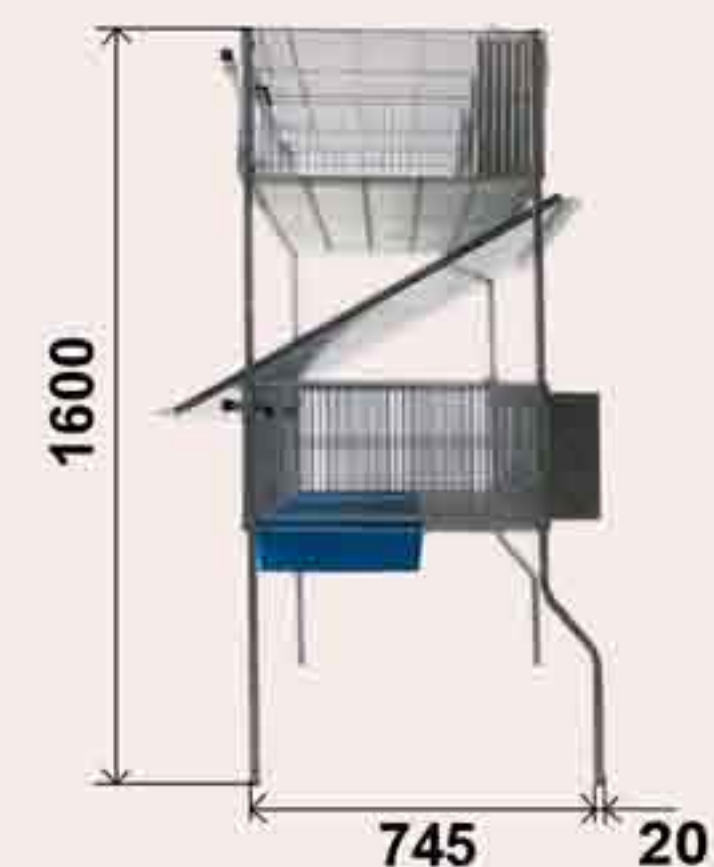



INICIO ALIMENTACION CENTRAL E.3 2400 Ref. 40.12013
PROLONGACION ALIMENTACION CENTRAL E.3 2400 Ref. 40.12014



INICIO CONTROL LACTANCIA SEMIAUTOMATICA
E.3 2400 Ref. 40.12015
PROLONGACION CONTROL LACTANCIA E.3 2400 Ref. 40.12021

INICIO CONTROL LACTANCIA AUTOMATICA
E.3 2400 Ref. 40.12016



INICIO ALIMENTACION DESPLAZADA E.3 2400 Ref. 40.12017
PROLONGACION ALIMENTACION DESPLAZADA E.3 2400 Ref. 40.12018



INICIO ALIMENTACION DIFERENCIADA E.3 2400 Ref. 40.12019
PROLONGACION ALIMENTACION DIFERENCIADA E.3 2400 Ref. 40.12020



TECNI EQUIP ANIMAL S.L.

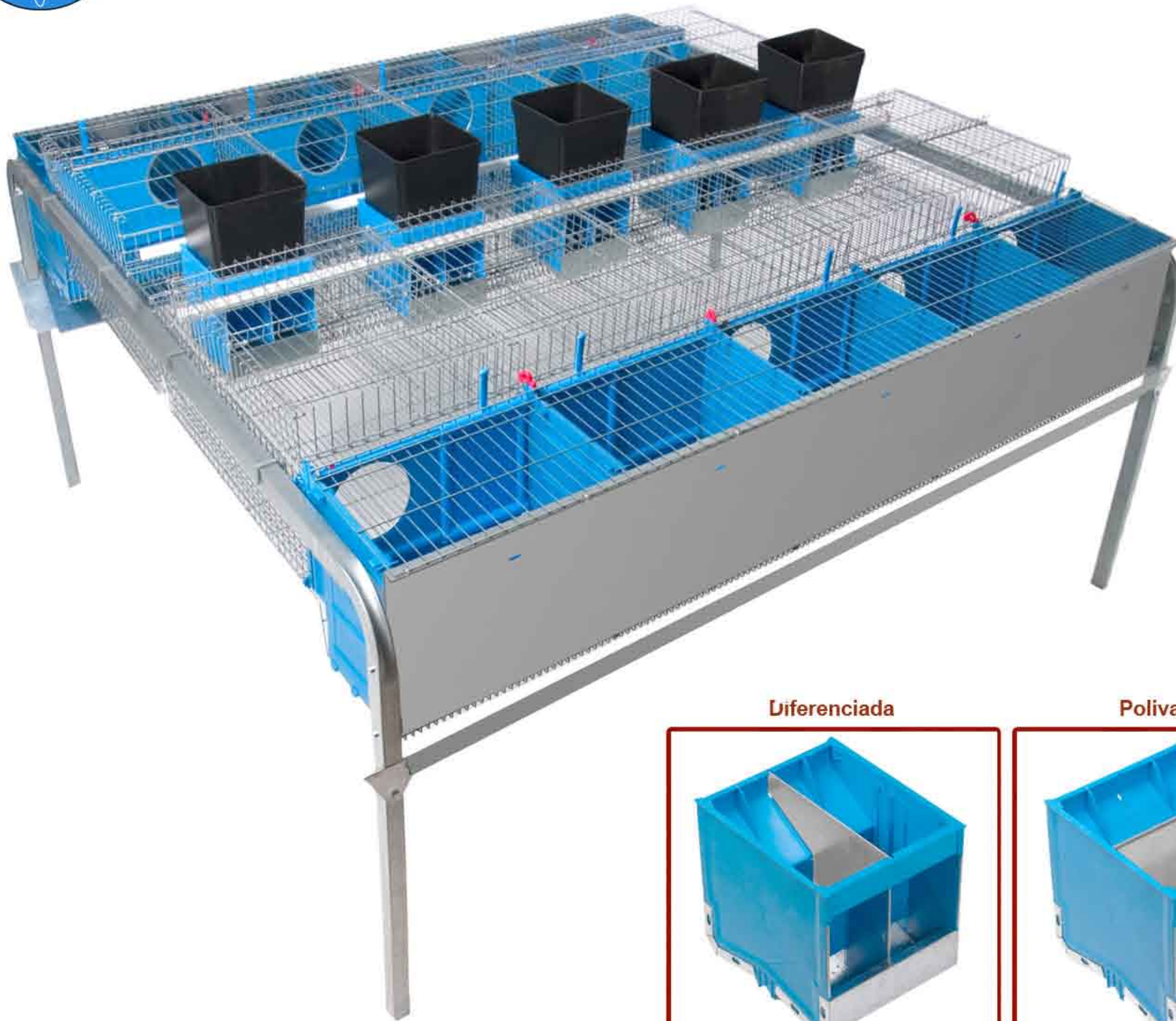

Diferenciada

Polivalente

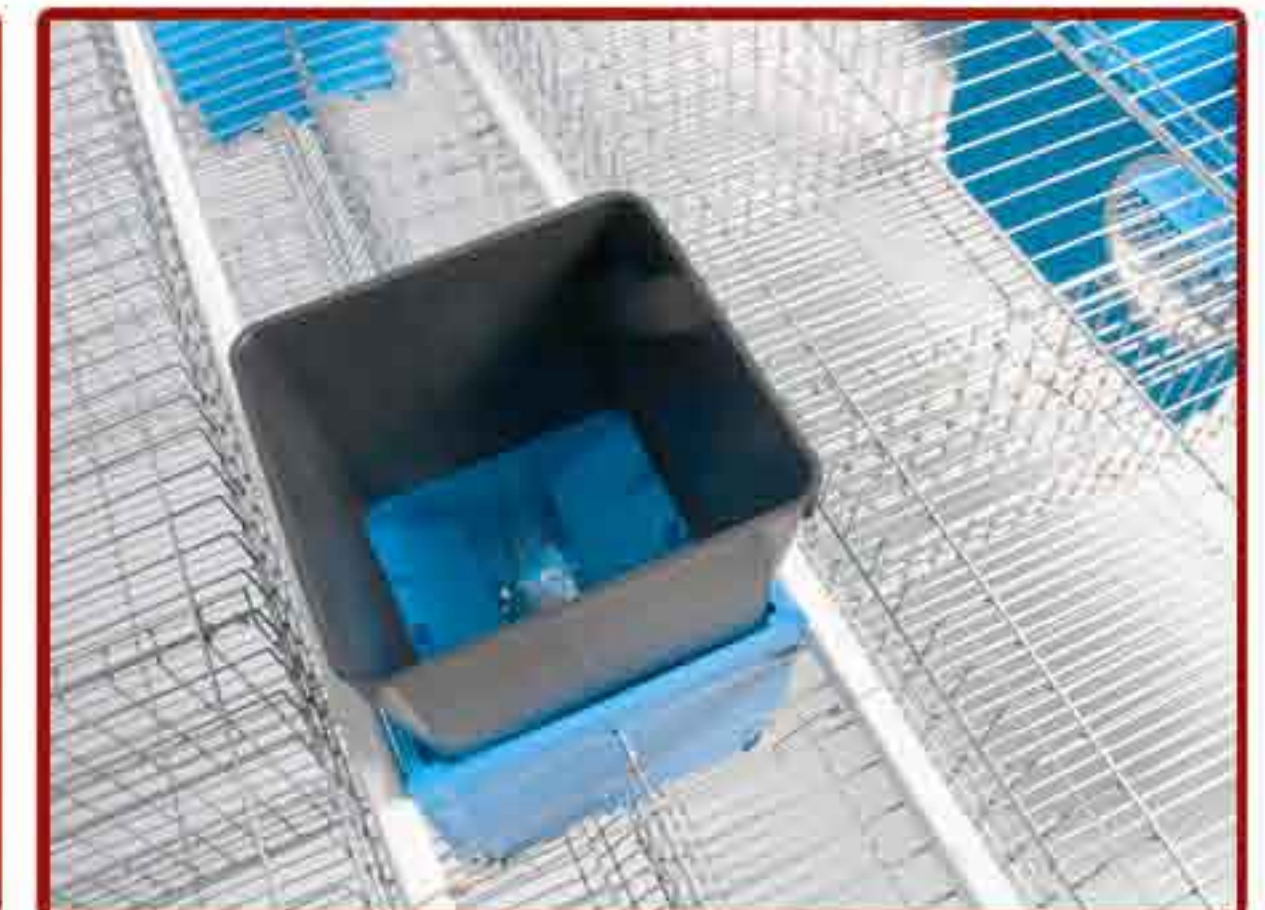

E.3 MODULO MEGA B 10/5-T F 1800 ADAPTABLE, ALIMENTACION POLIVALENTE Y DIFERENCIADA CON ALIMENTACION AUTOMATICA



TECNEQUIP ANIMAL S.L.

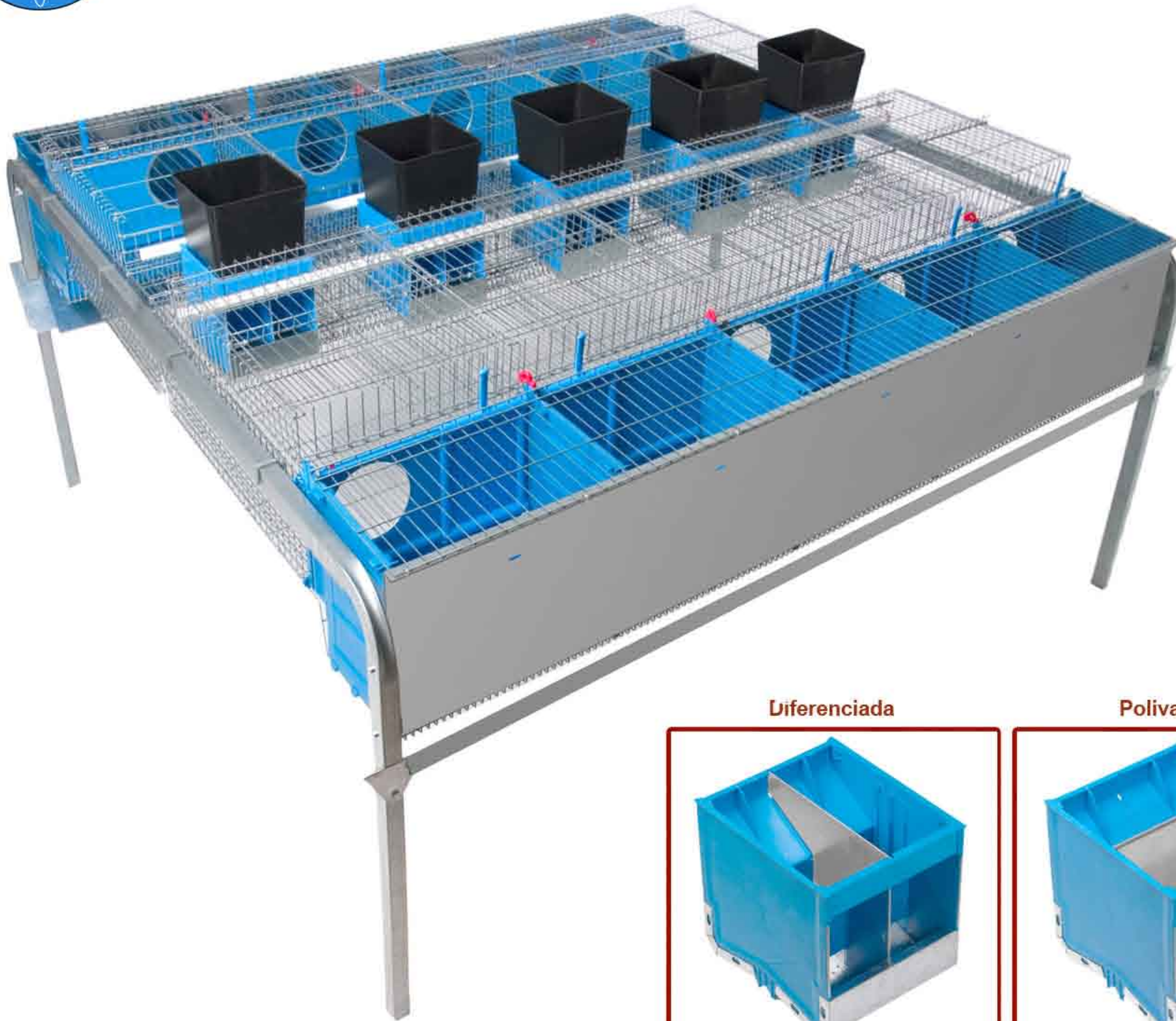

Diferenciada

Polivalente

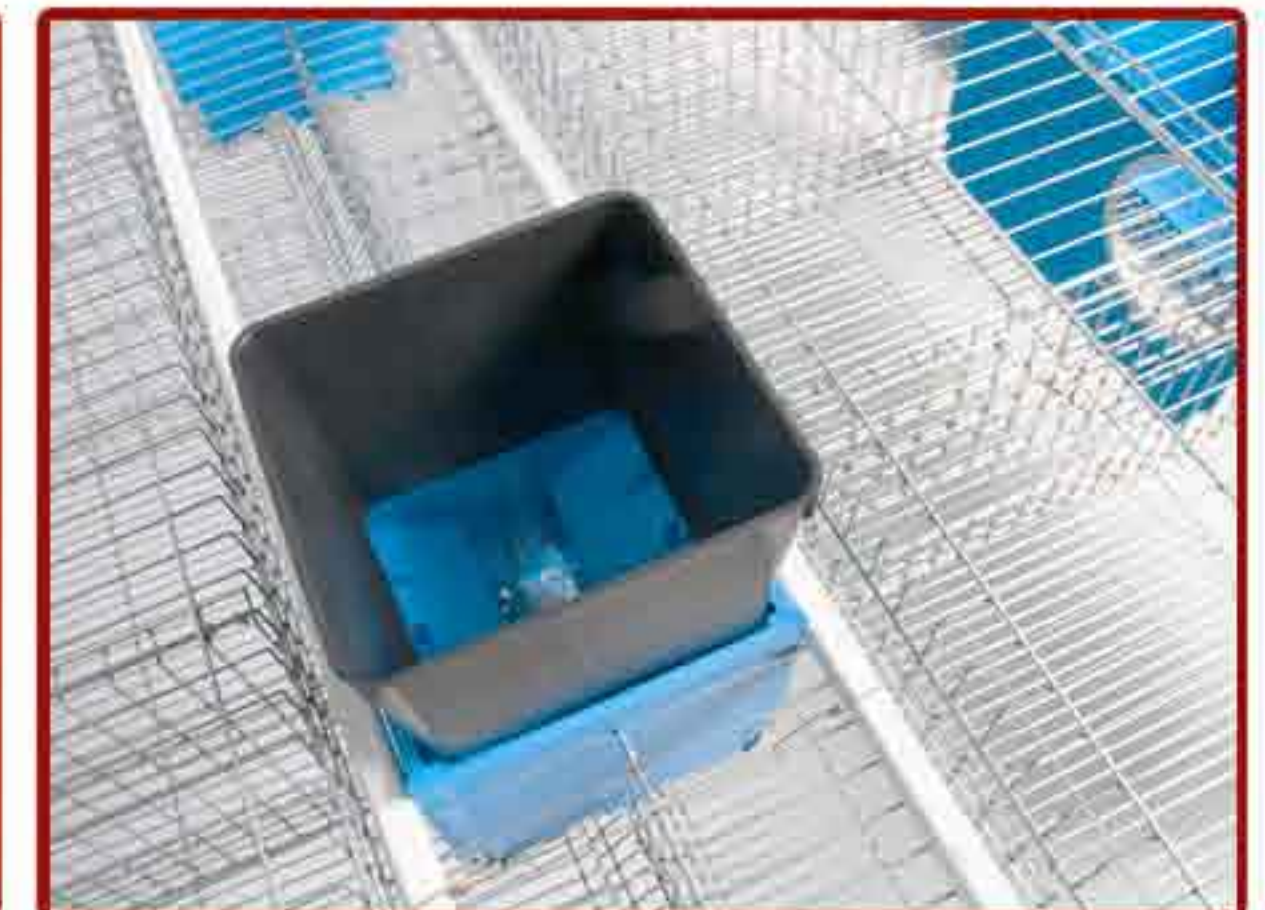

E.3 MODULO MEGA B 10/5-T F2000 ADAPTABLE, ALIMENTACION POLIVALENTE Y DIFERENCIADA CON ALIMENTACION AUTOMATICA

ACCESORIOS



Ref. 3.4550
Comedero 4 doble



Ref. 3.4551
Supl. comedero



Ref. 3.4552
Delantero nido 40



Ref. 3.4553
Trampilla nido



Ref. 3.4554
Tramp. nido gatera



Ref. 3.3840
Cuna profunda



Ref. 3.4555
Nido cuna 40



Ref. 3.4557
Nido 40



Ref. 3.3792
Rejilla sandwich

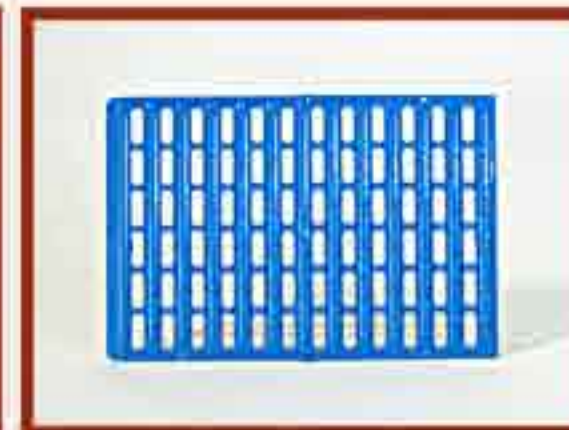

Ref. 3.4558
Curapatas



Ref. 3.4576
Caña para 6 minis



Ref. 3.4636
Caña 6 chupetes
2400



Ref. 3.4559
Protector orines



Ref. 3.4584
Tapa nido 40



Ref. 3.5128
Deposito reg. 8 l.



Ref. 3.525
18x22x38
Tolva cuadruple alta



Ref. 3.526
18x22x31
Tolva cuadruple baja

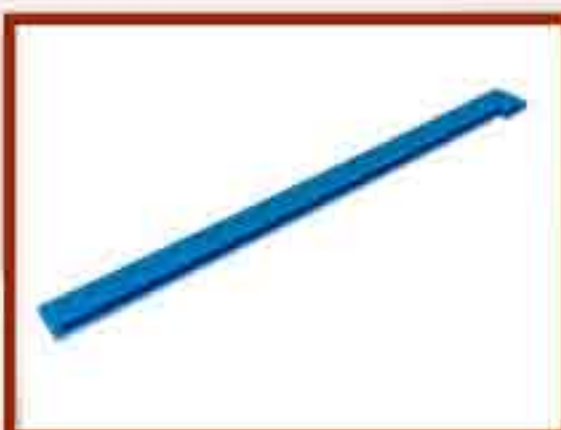

Ref. 3.4589
Perfil escuadra
sup. azul



Ref. 46.1023
13x16cm.
Portafichas con ficha
control

MODULO MEGA B 10/5-T F1800

Todo el material metálico utilizado (alambre, chapa y tubo) es galvanizado de alta calidad, como es norma en Tecniequip. Los materiales plásticos son vírgenes y **no tóxicos**. Módulos polivalentes únicos en el mercado, de fácil adaptación a cualquier manejo. Adaptable a cualquier automatismo de alimentación y lactancia controlada (opcionales). Comederos diseñados para el mejor aprovechamiento del alimento y para alimentación diferenciada (opcional), con suplemento tolva para el aumento de capacidad (opcional), eliminando pérdidas.

La empresa no se hace responsable en caso de no utilizar con los equipos, materiales originales Tecniequip. El precio del módulo es sin accesorios (en la fotografía esta con accesorios).

INTERIOR DEPARTAMENTO 400X1000X310

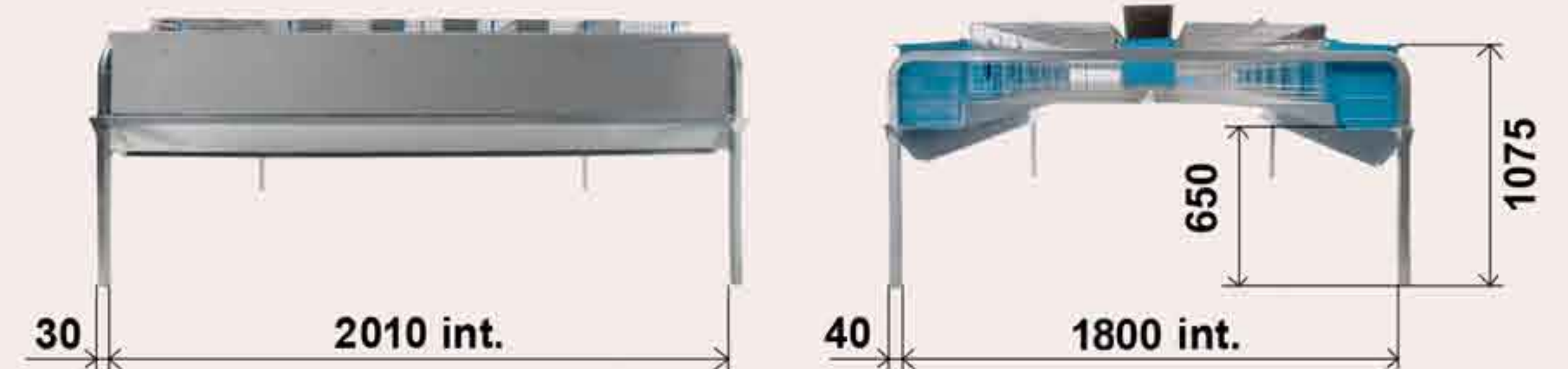

ACCESORIOS



Ref. 3.4550
Comedero 4 doble



Ref. 3.4551
Supl. comedero



Ref. 3.4552
Delantero nido 40



Ref. 3.4553
Trampilla nido



Ref. 3.4554
Tramp. nido gatera



Ref. 3.3840
Cuna profunda



Ref. 3.4555
Nido cuna 40



Ref. 3.4557
Nido 40



Ref. 3.3792
Rejilla sandwich



Ref. 3.4558
Curapatas



Ref. 3.4576
Caña para 6 minis



Ref. 3.4636
Caña 6 chupetes
2400



Ref. 3.4559
Protector orines



Ref. 3.4584
Tapa nido 40



Ref. 3.5128
Deposito reg. 8 l.



Ref. 3.525
18x22x38
Tolva cuadruple alta



Ref. 3.526
18x22x31
Tolva cuadruple baja

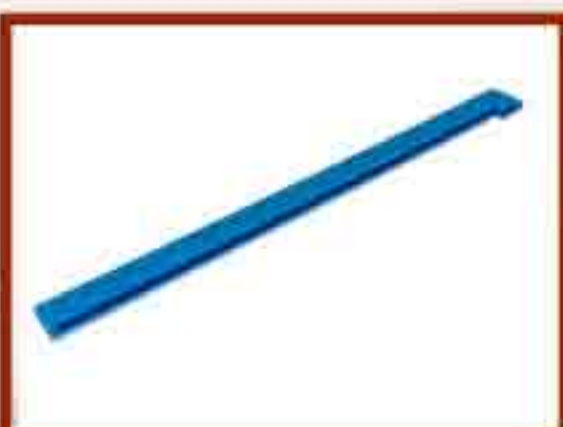

Ref. 3.4589
Perfil escuadra
sup. azul



Ref. 46.1023
13x16cm.
Portafichas con ficha
control

MODULO MEGA B 10/5-T F2000

Todo el material metálico utilizado (alambre, chapa y tubo) es galvanizado de alta calidad, como es norma en Tecniequip. Los materiales plásticos son vírgenes y no tóxicos. Módulos polivalentes únicos en el mercado, de fácil adaptación a cualquier manejo. Adaptable a cualquier automatismo de alimentación y lactancia controlada (opcionales). Comederos diseñados para el mejor aprovechamiento del alimento y para alimentación diferenciada (opcional), con suplemento tolva para el aumento de capacidad (opcional), eliminando pérdidas.

La empresa no se hace responsable en caso de no utilizar con los equipos, materiales originales Tecniequip. El precio del modulo es sin accesorios (en la fotografía esta con accesorios).

INTERIOR DEPARTAMENTO 400X1000X310

